

PART7

TERMINAL BLOCKS



TEST TERMINAL BLOCKS
TERMINAL BLOCKS

TERMINAL BLOCKS

Quick Selection Guide

Type		Rated Current	No. of Poles	Model Number
Fixing Type	Normal	10A	10	KH-6010-10P
		20A	3	KH-6020-3P
		20A	4	KH-6020-4P
		20A	6	KH-6020-6P
		20A	8	KH-6020-8P
		20A	10	KH-6020-10P
		20A	12	KH-6020-12P
		20A	15	KH-6020-15P
		20A	20	KH-6020-20P
		30A	3	KH-6030-3P
		30A	4	KH-6030-4P
		30A	6	KH-6030-6P
		30A	10	KH-6030-10P
		45A	10	KH-6045-10P
		60A	3	KH-6060-3P
		60A	4	KH-6060-4P
		100A	3	KH-60100-3P
		100A	4	KH-60100-4P
		150A	3	KH-60150-3P
		200A	3	KH-60200-3P
		200A	4	KH-60200-4P
		300A	3	KH-60300-3P
		300A	4	KH-60300-4P
500A	3	KH-60500-3P		
500A	4	KH-60500-4P		
	Module Combination Type	25A	3~20	KTB25
	Common Terminal Type	15A	6	KH-6015-C
DIN rail Type	Single Level type (with Spring Clamp)	10A	-	KH-6110S
		15A	-	KH-6115S
		20A	-	KH-6120S
	Single Level type	30A	-	KH-6130
		60A	-	KH-6160
	Double level type	15A	-	KH-6215
Dual Type (Fixing Type/DIN rail Type)		100A	2	KH-65100-2P
		100A	3	KH-65100-3P
		100A	4	KH-65100-4P
		200A	2	KH-65200-2P
		200A	3	KH-65200-3P
		200A	4	KH-65200-4P
		350A	2	KH-65350-2P
		350A	3	KH-65350-3P
		350A	4	KH-65350-4P

KTB25 Module Combination Type

Easily combine 3P and 4P bodies
to make 3P ~ 20P terminal block.
(see next page.)



KTB25

Specification

Model	KTB25
Rated Voltage	600V
Rated Current	25A(250V)
Insulation Resistance	100MΩ min.
Dielectric Strength	2,500 VAC for 1min.
Ambient Temp.	-20~+55
Terminal Screw	M4
Fixing Screw	M4
Material	Nylon Glass

If Longer than 20P

Using elongation fixing unit, can make
20P~50P terminal block.

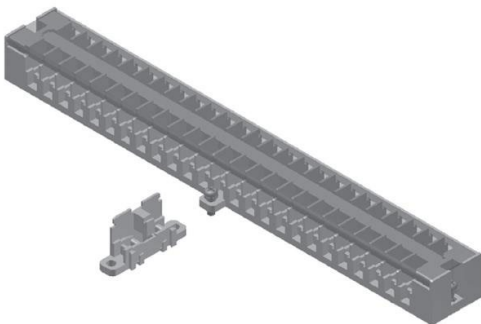

KTB25 Module Combination Type

Combination Example (10P)

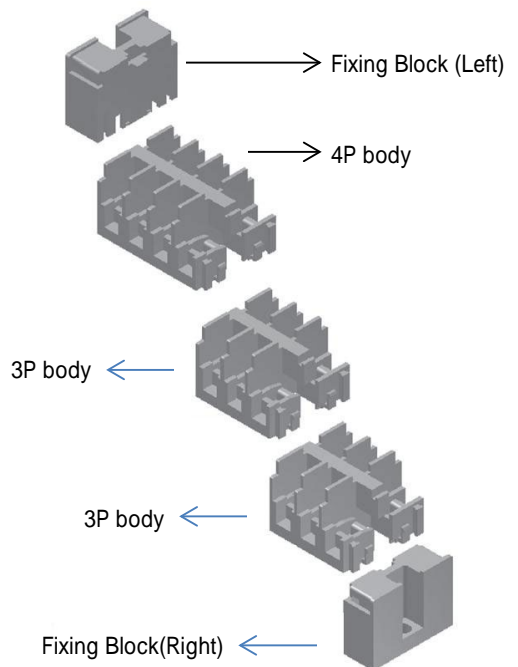

TERMINAL BLOCKS

Fixing Type

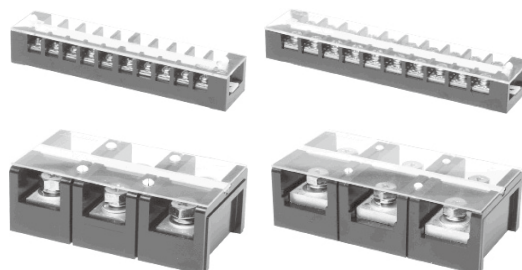





Specification

Model		KH-6010	KH-6020	KH-6030	KH-6045	KH-6060
Rated Voltage		600V				
Rated Current		10A(250V)	20A(250V)	30A(250V)	45A(250V)	60A(250V)
Insulation Resistance		100MΩ min.				
Dielectric Strength		2,500 VAC for 1min.				
Wire		2mm ²	3.5mm ²	5.5mm ²	8mm ²	22mm ²
Terminal Screw		M3	M4	M4.5	M5	M6
Wiring Rug	E	10.0mm	10.0mm	14.5mm	14.5mm	14.5mm
	F	3.1	4.1	4.6	5.1	6.1
	W	6.8mm	8.3mm	9.8mm	12mm	16.8mm
	L	20.6mm	21.5mm	26.5mm	26.5mm	35.5mm
Material	Body	Phenol				
	Cover	ABS(transparent)				
	Terminal	Brass				
	Plate	PVC(white)				

Model		KH-60100	KH-60150	KH-60200	KH-60300	KH-60500
Rated Voltage		600V				
Rated Current		100A(250V)	150A(250V)	200A(250V)	300A(250V)	300A(250V)
Insulation Resistance		100MΩ min.				
Dielectric Strength		2,500 VAC for 1min.				
Wire		38mm ²	60mm ²	100mm ²	150mm ²	200mm ²
Terminal Screw		M8	M10	M10	M12	M12
Wiring Rug	E	20.5mm	20.5mm	20.5mm	25.5mm	30.0mm
	F	8.1	10.1	10.1	12.2	12.2
	W	22.3mm	22.3mm	28.9mm	36.5mm	44.5mm
	L	45.5mm	45.5mm	50.5mm	55.5mm	65.5mm
Material	Body	Phenol				
	Cover	ABS(transparent)				
	Terminal	Brass				
	Plate	PVC(white)				

TERMINAL BLOCKS



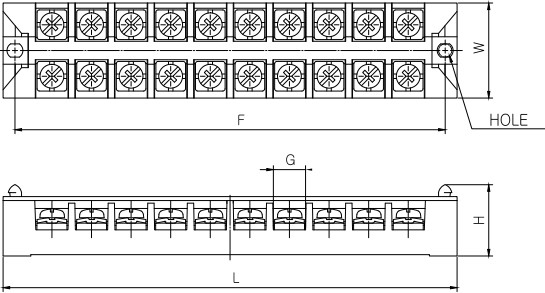
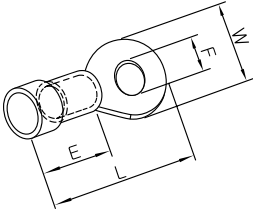



Outline Dimensional Drawing;

Fixing Type Terminal Blocks	Fixing Type Terminal Blocks	Wiring Rug
 <p>KH-6010</p>  <p>KH-6020</p>  <p>KH-6030</p>  <p>KH-6045</p>		

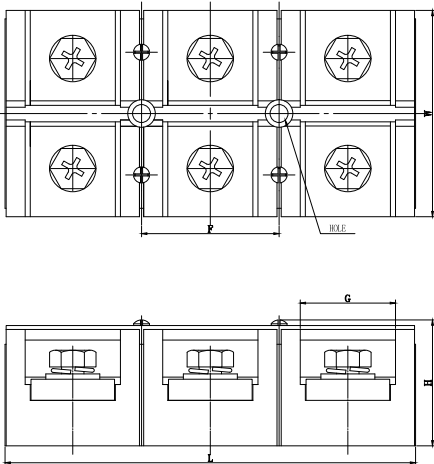
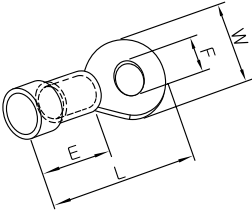
Model	Rating/Pole	F(mm)	G(mm)	Hole(Φ)	L(mm)	W(mm)	H(mm)	Weight
KH-6010-10P	10A 10P	104	7	5	113	23	27	27g
KH-6020-3P	20A 3P	45	8.5	5	54	30	27	47g
KH-6020-4P	20A 4P	57	8.5	5	66	30	27	58g
KH-6020-6P	20A 6P	80	8.5	5	89	30	27	82g
KH-6020-8P	20A 8P	103	8.5	5	112	30	27	103g
KH-6020-10P	20A 10P	127	8.5	5	136	30	27	127g
KH-6020-12P	20A 12P	151	8.5	5	160	30	27	152g
KH-6020-15P	20A 15P	187	8.5	5	196	30	27	185g
KH-6020-20P	20A 20P	242	8.5	5	251	30	27	245g
KH-6030-3P	30A 3P	50.8	10	5	60	33	27	63g
KH-6030-4P	30A 4P	64	10	5	73	33	27	77g
KH-6030-6P	30A 6P	90.4	10	5	100	33	27	110g
KH-6030-10P	30A 10P	144	10	5	156	33	27	172g
KH-6045-10P	45A 10P	163	12.2	5	171	36	27	235g

TERMINAL BLOCKS

Outline Dimensional Drawing;

Product	Fixing Type Terminal Blocks	Wiring Rug
 KH-6060		
 KH-60100		
 KH-60150		
 KH-60200		
 KH-60300		
 KH-60500		

Model	Rating/Pole	F(mm)	G(mm)	Hole(Φ)	L(mm)	W(mm)	H(mm)	Weight
KH-6060-3P	60A 3P	28	16	5.2	85	40	36	142g
KH-6060-4P	60A 4P	57	16	5.2	113	40	36	190g
KH-60100-3P	100A 3P	35	23	6.5	105	56	41.5	300g
KH-60100-4P	100A 4P	70	23	6.5	140	56	41.5	406g
KH-60150-3P	150A 3P	38.5	22.5	7.2	116	68	45.5	499g
KH-60200-3P	200A 3P	45	28.8	7.2	135	73	49.5	591g
KH-60200-4P	200A 4P	90	28.8	7.2	180	73	49.5	796g
KH-60300-3P	300A 3P	52	37	8.5	155	83	54	939g
KH-60300-4P	300A 4P	104	37	8.5	208	83	54	1,278g
KH-60500-3P	500A 3P	65	45	8.5	194	97.5	59.5	1,615g
KH-60500-4P	500A 4P	130	45	8.5	260	97.5	59.5	2,163g

TERMINAL BLOCKS

Fixing Type Terminal Blocks

KH-6010

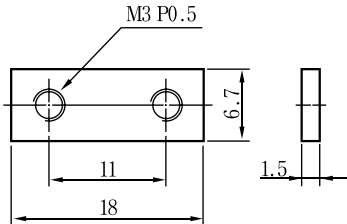

KH-6020

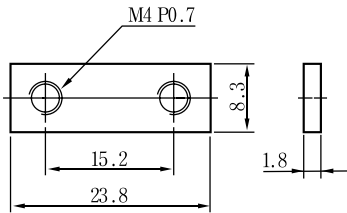

KH-6030

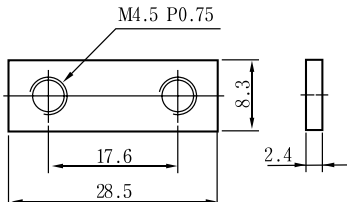

KH-6045

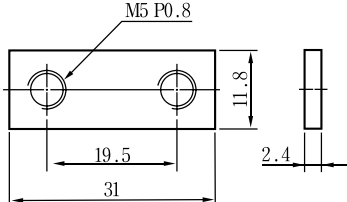

KH-6060

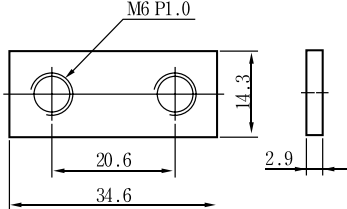

KH-60100

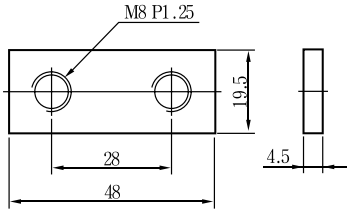

KH-60150

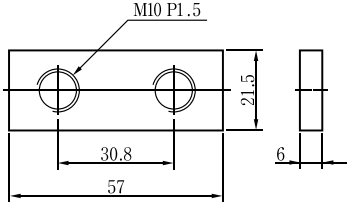

KH-60200

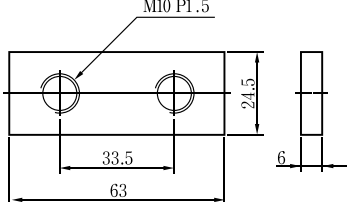

KH-60300

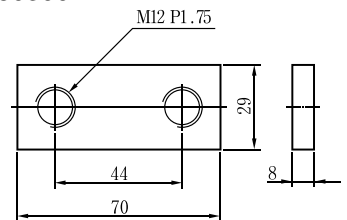

KH-60500

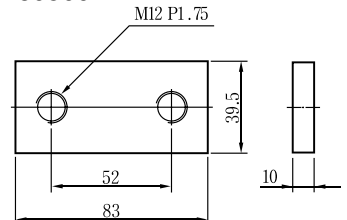

SQUARE LIGHT

TOWER LIGHT

BUZZER

TIMER & COUNTER

RELAY

SOCKETS

TERMINAL BLOCKS

CONTROL BOX

TERMINAL BLOCKS

KH-6015C

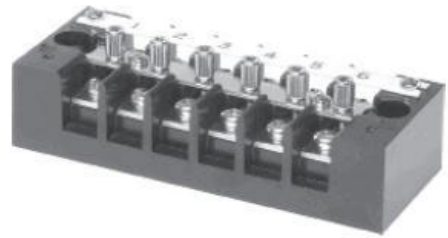

Specification

Model	KH-6015-C	
Rated Voltage	600V	
Rated Current	15A(250V)	
Insulation Resistance	100MΩ min.	
Dielectric Strength	2,500 VAC for 1min.	
Wire	8mm ²	
Terminal Screw	M5	
Wiring Rug	E	10.0mm
	F	5.1
	W	12.7mm
	L	23.0mm
Material	Body	Phenol
	Terminal	Brass
Material	Plate	PVC(white)
Weight	270g	

Wiring Rug

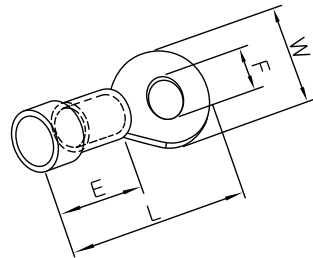

Dimensions

KH-6015-C

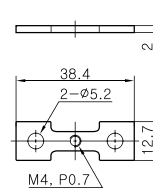
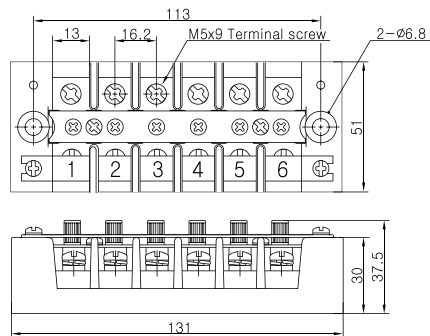

DIN-rail type



KH-6110S

KH-6115S

KH-6120S

Specification

Model		KH-6110S	KH-6115S	KH-6120S
Rated Voltage		600V		
Rated Current		10A(250V)	15A(250V)	20A(250V)
Insulation Resistance		100MΩ min.		
Dielectric Strength		2,500 VAC for 1min.		
Wire		1.25mm ²	2mm ²	3.5mm ²
Terminal Screw		M3	M3.5	M4
Wiring Rug	E	10.0mm	10.0mm	14mm
	F	3.1	3.6	4.1
	W	5.7mm	6.7mm	8.3mm
	L	21.0mm	21.0mm	27.0mm
Material	Body	Noryl		PC
	Cover	PC (transparent)		
	Terminal	Brass		
	Plate	PVC (white)		
Weight	Weight	6.5g	7.7g	12g

Dimensions

Model	A	B	C	D	E	F	G	H
KH-6110S	5.7	1	24	M3	7X(N-1)+60	7X(N-1)+13	37.5	39
KH-6115S	6.6	1	25	M3.5	8X(N-1)+61	8X(N-1)+14	37.5	39
KH-6120S	8.5	1.6	27.5	M4	10.5X(N-1)+63	10.5X(N-1)+16	37.5	39

KH-6110S, KH-6115S

KH-6120S

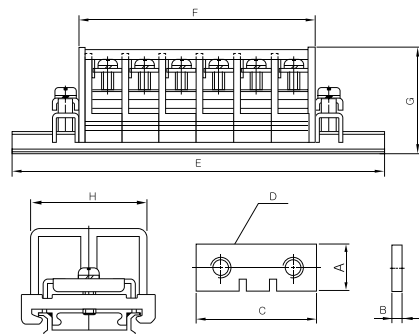
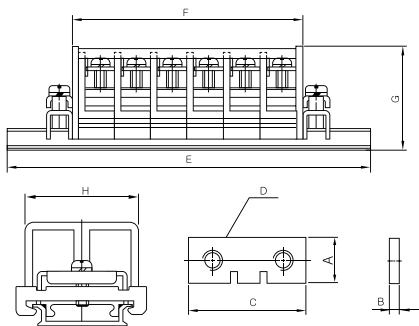

TERMINAL BLOCKS



KH-6130



KH-6160

Specification

Model	KH-6130	KH-6160	
Rated Voltage	600V		
Rated Current	30A(250V)	60A(250V)	
Insulation Resistance	100MΩ min.		
Dielectric Strength	2,500 VAC for 1min.		
Wire	5.5mm ²	14mm ²	
Terminal Screw	M4.5	M6	
Wiring Rug	E	14.0mm	14.5mm
	F	4.6	6.1
	W	9.8mm	13.6mm
	L	27.0mm	30.0mm
Material	Body	PC (black)	
	Cover	PC (transparent)	
	Terminal	Brass	
	Plate	PVC (white)	
Weight	15g	31g	

Wiring Rug

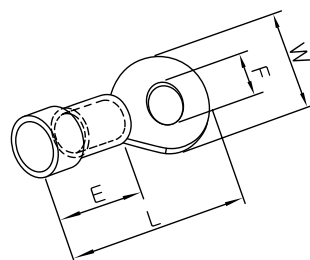

Dimensions

Model	A	B	C	D	E	F	G	H
KH-6130	9.8	2.4	28.5	M4.5	12.5X(N-1)+65	12.5X(N-1)+18	35.5	39
KH-6160	14.5	3.0	35.0	M6	17X(N-1)+70	17X(N-1)+24	41.5	45

KH-6130, KH-6160

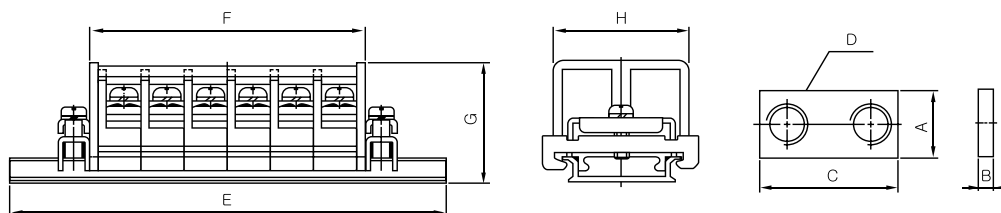

TERMINAL BLOCKS

DIN-rail type



KH-6215

Specification

Model	KH-6215	
Rated Voltage	600V	
Rated Current	15A(250V)	
Insulation Resistance	100MΩ min.	
Dielectric Strength	2,500 VAC for 1min.	
Wire	2.0mm ²	
Terminal Screw	M3.5	
Wiring Rug	E	10.0mm
	F	3.6
	W	6.8mm
	L	21.0mm
Material	Body	PC
	Cover	PC (transparent)
	Terminal	Brass
	Plate	PVC (white)
Weight	21g	

Wiring Rug

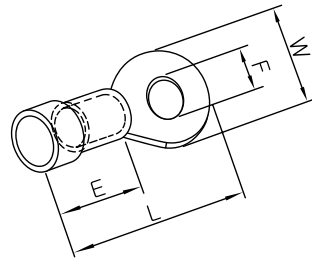

Dimensions

Model	E	F	G
KH-6215	$8.3X(N-1)+66$	$8.3X(N-1)+18$	63

KH-6215

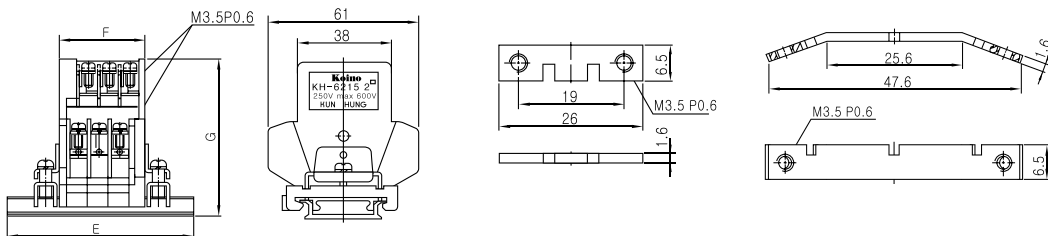

SQUARE LIGHT

TOWER LIGHT

BUZZER

TIMER & COUNTER

RELAY

SOCKETS

TERMINAL BLOCKS

CONTROL BOX

TERMINAL BLOCKS

Dual type

Can select Surface mounting
/DIN rail mounting



KH-65100



KH-65350



KH-65200

Specification

Model		KH-65100	KH-65200	KH-65350
Rated Voltage		600V		
Rated Current		100A(250V)	200A(250V)	350A(250V)
Insulation Resistance		100MΩ min.		
Dielectric Strength		2,500 VAC for 1min.		
Wire		38mm ²	60mm ²	100mm ²
Terminal Screw		M8	M10	M12
Wiring Rug	E	12.5mm	17.5mm	18.5mm
	F	8.4	10.5	13.0
	W	22mm	22mm	28.5mm
	L	43mm	50mm	56mm
Material	Body	Noryl (black)		
	Cover	PC (transparent)		
	Terminal	Brass		
	Plate	PC (white)		
Weight		71g	149g	248g

Stopper



Material: Steel

Use at two ends of DIN rail attached terminal blocks

TERMINAL BLOCKS

Dimensions

KH-65100 / KH-65200 / KH-65350

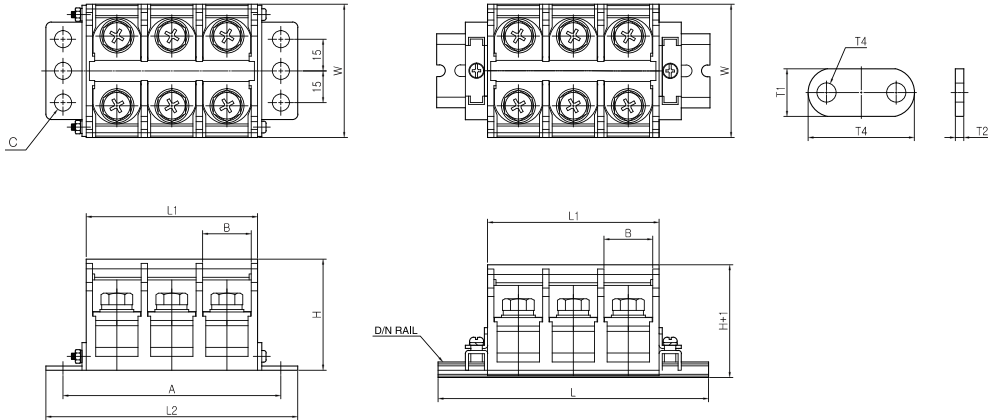

Model	A	B	ΦC	L1	L2	W	H	T1	T2	T3	T4
KH-65100-2P	77	23	8	55	93	63	52.5	22.5	4	50.2	9
KH-65100-3P	103	23	8	81	119	63	52.5	22.5	4	50.2	9
KH-65100-4P	129	23	8	107	145	63	52.5	22.5	4	50.2	9
KH-65200-2P	100	33	8	78	116	90	61	32.5	4	67.8	10.8
KH-65200-3P	137	33	8	115	153	90	61	32.5	4	67.8	10.8
KH-65200-4P	174	33	8	152	190	90	61	32.5	4	67.8	10.8
KH-65350-2P	142	52	8	119	158	120	75	50.8	4	90	13
KH-65350-3P	199	52	8	176	215	120	75	50.8	4	90	13
KH-65350-4P	256	52	8	233	272	120	75	50.8	4	90	13

DIN rail KH-TBR-2 & Stopper

KH-TBR-2



Material: Aluminum

1M & 2M available

Dimensions

KH-TBR-2

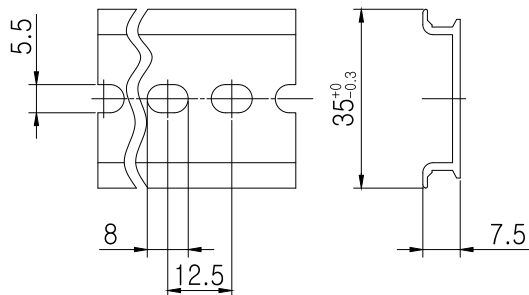

KOINO