

# PART 6

## SOCKETS



SOCKETS FOR RELAYS

SOCKETS (11pins)

SOCKETS (8pins)

# SOCKETS

## SOCKETS FOR RELAYS

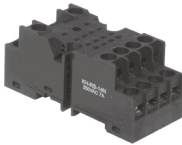
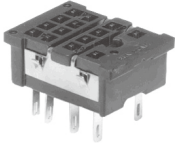
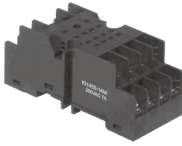
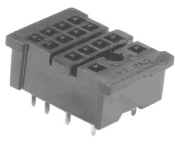
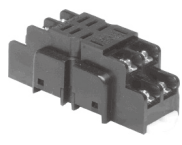
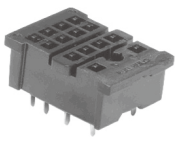
Item	Model	V/A	Item	Model	V/A
	KH-RS-14N KH-RS-14N-8	250V / 7A		KH-RS-P14-8	250V / 7A
	KH-RS-14M KH-RS-14M-8			KH-RS-PC14	
	KH-RS-H2C	250V / 10A		KH-RS-PC14-8	
	KH-RS-P14	250V / 7A			

## SOCKETS(11pins )

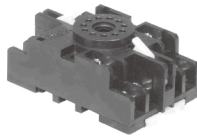
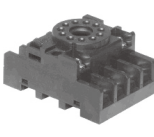

Item	Model	V/A	Item	Model	V/A
	KH-TDR-R11	250V / 10A		KH-RS-R11	250V / 10A

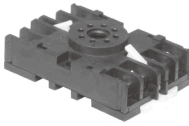
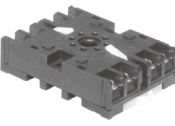
## SOCKETS(8pins )

Item	Model	V/A	Item	Model	V/A
	KH-TDR-R8	250V / 10A		KH-KTS-8	250V / 10A

# SOCKETS

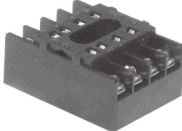
## SOCKETS(8pins )

Item	Model	V/A	Item	Model	V/A
	KH-RS-R8	250V / 10A		KH-RS-M8	250V / 7A
	KH-MR-8				

SQUARE  
LIGHT

TOWER  
LIGHT

BUZZER

TIMER &  
COUNTER

RELAY

SOCKETS

TERMINAL  
BLOCKS

CONTROL  
BOX

## SOCKETS FOR RELAYS

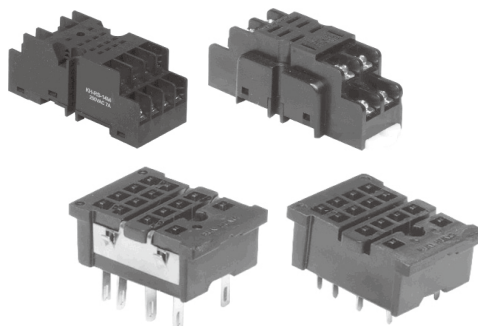

### Quick Selection Guide

Relay	Sockets	
	For DIN rail	Soldering terminal
KH-103-4C	KH-RS-14M	KH-RS-P14
	KH-RS-14N	KH-RS-PC14
KH-103-2C	KH-RS-14M-8	KH-RS-P14-8
	KH-RS-14N-8	KH-RS-PC14-8
KH-103-H2C	KH-RS-H2C	-

Model	KH-RS-14M	KH-RS-14M-8	KH-RS-H2C	KH-RS-P14	KH-RS-PC14
	KH-RS-14N	KH-RS-14N-8		KH-RS-P14-8	KH-RS-PC14-8
Ratings	250V 7A		250V 10A	250V 7A	
Insulation Resistance	100M (500VDC)				
Dielectric strength	2,000VAC 50/60Hz for 1 minute				
Terminal	M3 Screw		M3.5 Screw	Soldering terminal	Soldering terminal for PCB
Material	Nylon glass			Phenol resin	

### Terminal Diagram

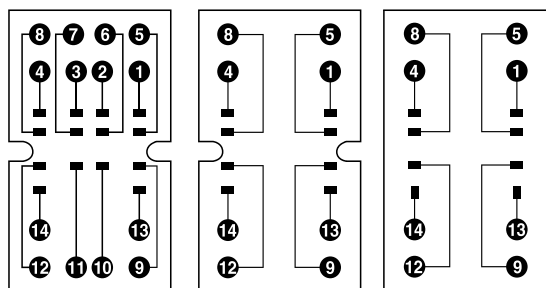

KH-RS-14N  
KH-RS-14M

KH-RS-14N-8  
KH-RS-14M-8

KH-RS-H2C

### Circuit Diagram

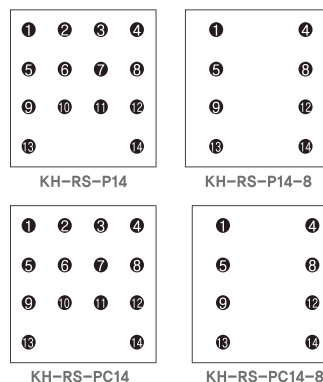

KH-RS-P14

KH-RS-P14-8

KH-RS-PC14

KH-RS-PC14-8

# SOCKETS

## Dimension

KH-RS-14N, KH-RS-14N-8

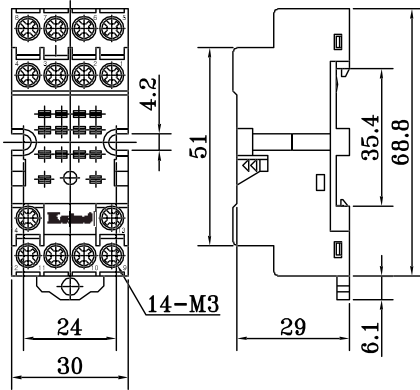

KH-RS-14M, KH-RS-14M-8

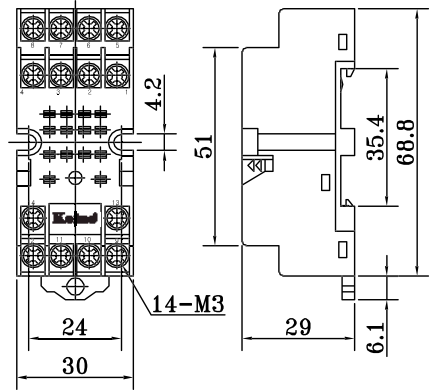

KH-RS-H2C

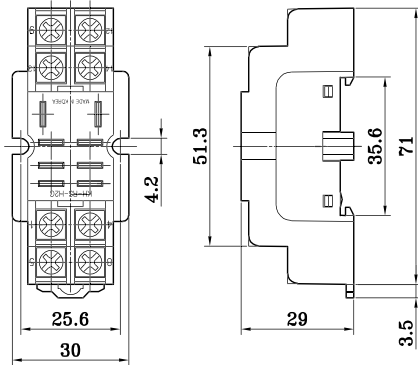

KH-RS-P14, KH-RS-P14-8

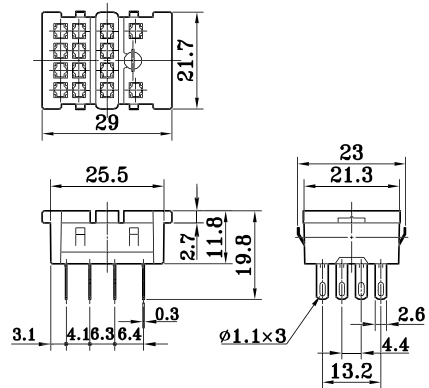

KH-RS-PC14, KH-RS-PC14-8

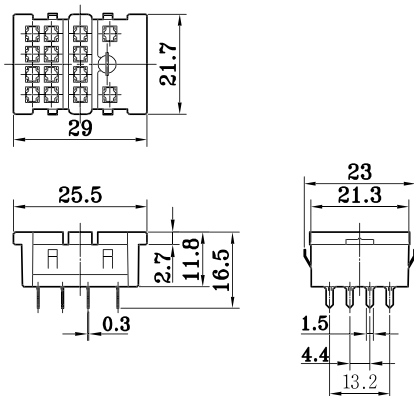

SQUARE LIGHT

TOWER LIGHT

BUZZER

TIMER & COUNTER

RELAY

SOCKETS

TERMINAL BLOCK

CONTROL BOX

# SOCKETS(11pins)

RoHS compliant :

“Surrounding air : 50°C Max.”

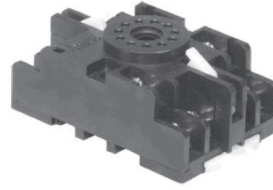

KH-TDR-R11



KH-RS-R11

## Selection Guide

Model		KH-TDR-R11	KH-RS-R11
Ratings		250V 10A	
Insulation Resistance		100M (500VDC)	
Dielectric strength		2,000VAC 50/60Hz for 1 minute	
Terminal		M3.5 Screw	
Material		PBT glass	
Wiring rug	E	4.5mm	4.5mm
	F	min. Ø3.6	min. Ø3.6
	W	7.6mm max.	7.6mm max.
	L	min. 15.7mm	min. 15.7mm

## Terminal Diagram

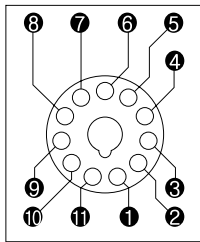

KH-TDR-R11

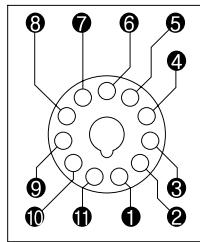

KH-RS-R11

## Line Terminal

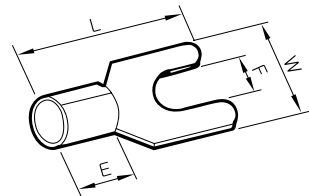

## Dimension

KH-TDR-R11

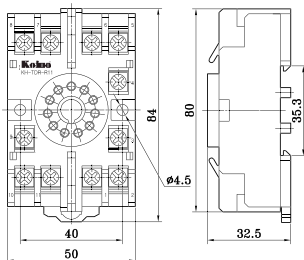

KH-RS-R11

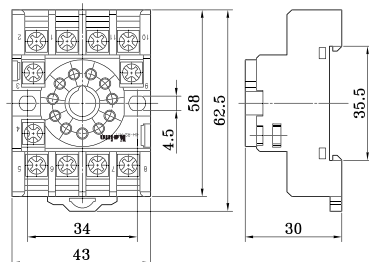

# SOCKETS(8pins)

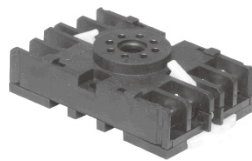

KH-TDR-R8

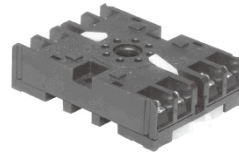

KH-KTS-8



KH-RS-R8



KH-MR-8

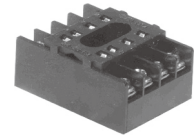

KH-RS-M8

RoHS compliant :

“Surrounding air : 50°C Max.”

for KH-TDR-R8 AND KH-RS-R8

## Selection Guide

Model	KH-TDR-R8	KH-KTS-8	KH-RS-R8	KH-MR-8	KH-RS-M8
Ratings	250V 10A				
Insulation Resistance	100M (500VDC)				
Dielectric strength	2,000VAC 50/60Hz for 1 minute				
Terminal	M3.5 Screw				M3 Screw
Material	PBT glass				Nylon glass
Wiring rug	E	4.5mm			
	F	min. Ø3.6			min. Ø3.1
	W	7.6mm max.	7.0mm max.		6.0mm max.
	L	min. 15.7mm			

## Terminal Diagram

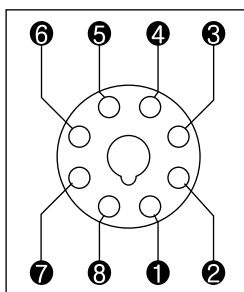

KH-TDR-R8  
KH-KTS-8  
KH-RS-R8  
KH-MR-8

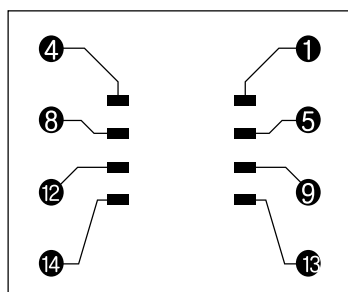

KH-RS-M8

## Line Terminal

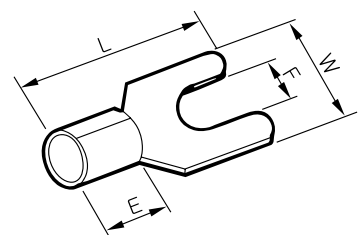

SQUARE LIGHT

TOWER LIGHT

BUZZER

TIMER & COUNTER

RELAY

SOCKETS

TERMINAL BLOCKS

CONTROL BOX

Dimension

KH-TDR-R8

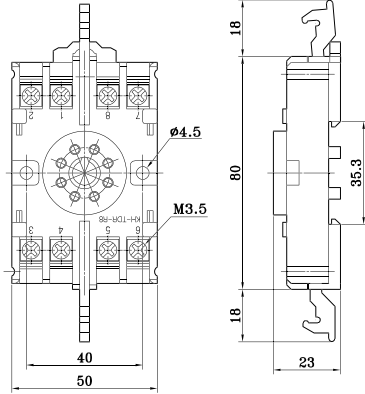

KH-KTS-8

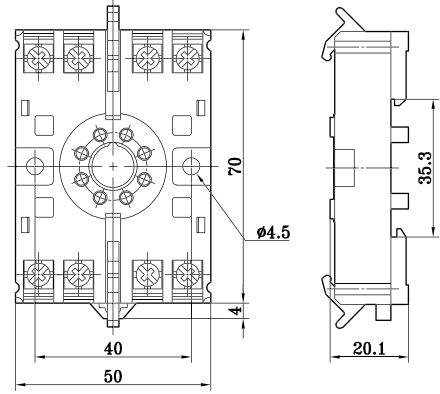

KH-RS-R8

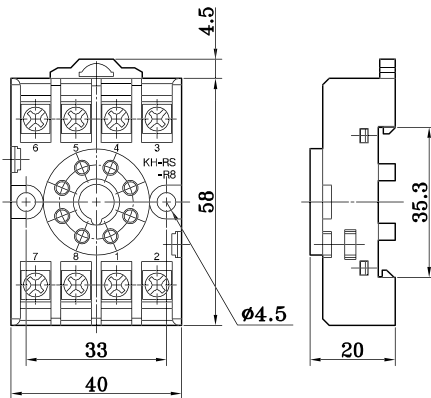

KH-MR-8

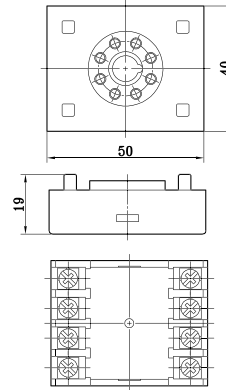

KH-RS-M8

