

PID CONTROLLER

Digital PID Controller User's Manual

HEATING & COOLING DUAL CONTROLER

K50-SERIES

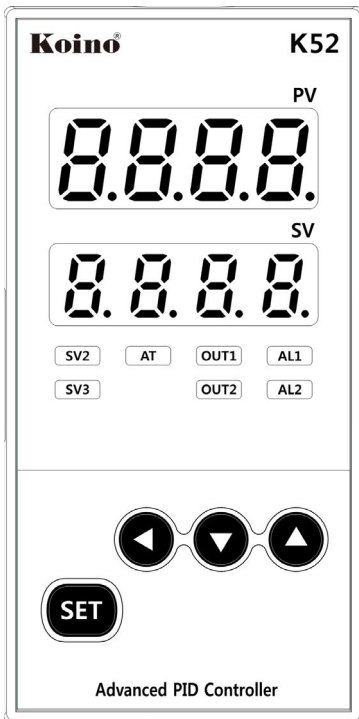

KOINO  KUNHUNG ELECTRIC

Useful Features!

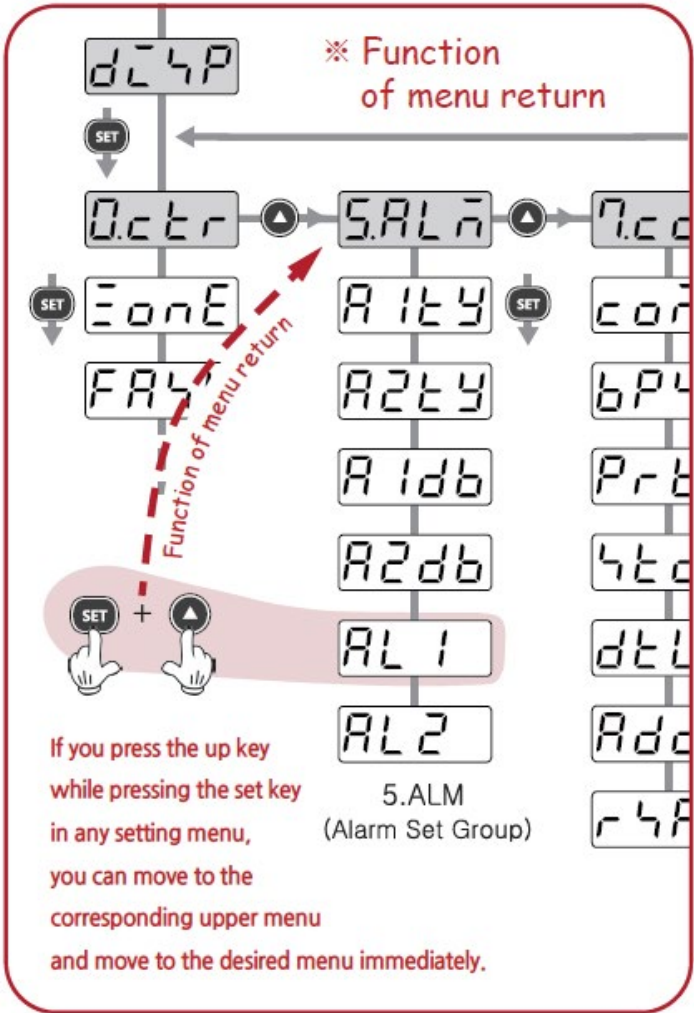

※ Use the menu return function to speed up the setting up to 10 times faster.

PHOTO SENSOR

PROXIMITY SENSOR

FLOATLESS LEVEL SWITCH

PID TEMP. CONTROLLER

Thank you for purchasing the K50 series from Koino.

The K50 series is a precision industrial controller that uses an advanced 2 degree - of - freedom (DOF) algorithm.

The K50 series consists of 5 models, which are K52, K53, K54, K57, and K59.

This manual explains the installation, the functions, the operation, and the handling of the products.

Please read the manual thoroughly before using the products.

If any difficulties arise while using our products, please contact our customer service email: jshong@koino.co.kr

Pay attention to the followings!

Use the products under the conditions specified in this manual.

Please heed the cautions and warnings listed in this manual.

The contents of the manual may be changed without notice.

The product is designed to be used installed on a control panel.

This manual is copyrighted, and may not be copied in part or in whole without permission.

The manufacturer takes no responsibility for direct or indirect damages caused by careless operation or operation under unpredictable or risky environments.

Safety requirements!

Safety requirements are intended to prevent accidents and dangers through the proper use of the products, so please heed them at all times.

The safety requirements are divided into “cautions” and “warnings”, which indicate the following.

WARNING

Serious injury or death may be caused if instructions are not observed.

CAUTION

Failure to observe these instructions may cause damage to the instrument or some injury to the user.

WARNING

1. Use a separate safety device when this product is used to control a device that could harm lives or expensive property in the event of a malfunction or a breakdown. (This may cause fires, deaths, or damage to property)
2. Do not use this controller at place where there are flammable or explosive gas. (It may cause a fire or explosion.)
3. Before turning the power on, please check that wiring is correct to the number of terminal. (It may cause a fire)
4. Turn off the power during wiring and maintenance to avoid an electric shock.
5. Do not touch the terminals when it is power on.
(It may give an electric shock.)
6. This controller must be mounted on the panel to avoid an electric shock.
7. Do not attempt to disassemble, modify and repair.

CAUTION

1. Please conduct an inspection when water has entered the product.
(It may cause short circuits, fires, and malfunction.)
2. This controller should be used indoors.
(It may shorten the controller ' s life or give an electric shock.)
3. Observe the rated voltage and specification.
(It may cause a fire or shorten the controller ' s life.)
4. Be careful that any of foreign materials do not inflow into the controller.
(It may cause a fire or malfunction of the controller.)
5. Do not give direct vibration or shock to the controller.
(It may cause of malfunction of the controller.)
6. Do not use chemical detergent or solvent, but use a dry towel in cleaning the controller.
(It may cause an electric shock or a fire.)
7. Please check the polarity of power before wiring and connecting the sensor.
(It may cause an electric shock or explosion.)

Contents

1. Ordering Information	105
2. Input ranges & Output constitutions	107
3. Dimensions & Panel cutouts	110
4. Terminal Arrangements & wirings	113
5. Ratings & Specifications	115
6. Name & Function	116
7. Check points before using	117
8. Initial installation & Min. operation procedures	118
9. Entering into "set menu" and Setting method	119
10. Flow chart (Parameter structure)	121
11. Easy function & Safety function	122
12. Functions of each setting group	124
[0] Control group setting	124
[1] Set value(SV) group setting	125
[2] Auto tuning(AT) group setting	125
[3] P.I.D group setting	126
[4] Heater break alarm(HBA) group setting	128
[5] Alarm(ALARM1,2) group setting	129
[6] Retransmission group setting	131
[7] Communication group setting	131
[8] Output group setting	134
[9] Input group setting	135

PID CONTROLLER

1. Ordering Information

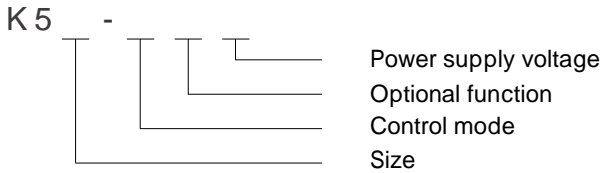

① Size

Code	Model	Size	Remarks
2	K52 - SERIES	48(W) × 96(H) × 77(D)	Option : 0, 1, 2
3	K53 - SERIES	96(W) × 48(H) × 77(D)	Option : 0, 1, 2
4	K54 - SERIES	48(W) × 48(H) × 99(D)	Option : 0, 1, 2, 3, 4, 5, 6
7	K57 - SERIES	72(W) × 72(H) × 77(D)	Option : 0, 1, 2
9	K59 - SERIES	96(W) × 96(H) × 77(D)	Option : 0, 1

Control mode

Code	Description	Remarks
S	Dual	Heating and Cooling control

Power supply voltage

Code	Description	Remarks
0	100 ~ 240 V AC	General - purpose usage
1	24 V AC or DC	Alternating or Direct current usage

PID CONTROLLER

Optional function

Model	Code	Description	Remarks
K52, K53 SERIES	Basic function	RELAY output 1, Alarm output 2,	Basic function + (Option code)
		SCR(4~20mA), SSR(Voltage pulse) 1,	
		RET(4~20mA Retransmission output)	
	0	D.I (SV2, 3) External digital input	Ex) K52, K53 - S00
	1	Communication (RS - 485, Modbus)	Ex) K52, K53 - S10
2	HBA(CT) Heater break alarm	Ex) K52, K53 - S20	
K54 SERIES	Basic function 0	RELAY output 1 (ALARM or MAIN), SCR(4~20mA), SSR(Voltage pulse) 1	Basic function + Option code (0 : No option)
	1	RET(4~20mA Retransmission), Alarm 2	Ex) K54 - S10
	2	HBA(Heater break alarm), Alarm output 2	Ex) K54 - S20
	3	D.I(SV2, 3) External input, Alarm output 2	Ex) K54 - S30
	4	RET(4~20mA Retransmission), Communication (RS - 485, Modbus)	Ex) K54 - S40
	5	HBA(CT) Heater break alarm, Communication (RS - 485, Modbus)	Ex) K54 - S50
	6	D.I(SV2, 3) External input, Communication (RS - 485, Modbus)	Ex) K54 - S60
K57 SERIES	Basic function 0	RELAY output 1, Alarm output 2, SCR(4~20mA), SSR(Voltage pulse) 1	Basic function + Option code (0 : No option)
	1	Communication (RS - 485, Modbus), RET(4~20mA Retransmission), HBA(CT) Heater break alarm	Ex) K57 - S10
	2	D.I(SV2, 3), RET(4~20mA Retransmission), HBA(CT) Heater break alarm	Ex) K57 - S20
K59 SERIES	Basic function 0	RELAY output 1, Alarm output 2, SCR(4~20mA), SSR(Voltage pulse) 1, RET(4~20mA Retransmission)	Basic function + Option code (0 : No option)
	1	Communication (RS - 485, Modbus), HBA(CT) Heater break alarm	Ex) K59 - S10

2. Input ranges and output constitutions

2-1. Input ranges The K50 series has multiple inputs, which may be set and changed by the user.

Input type	Signal	Setting Code	Temperature range	Accuracy	Remarks
Thermocouple (T.C)	K	1	-200 ~ 1370	± 0.3% of F.S +1Digit	* F.S is max. value to min. value of each range * Digit is minimum of display 0~400 range : ± 10% of F.S+1Digit
		2	-199.9 ~ 999.9		
	J	15	-200 ~ 1000		
		3	-199.9 ~ 999.9		
	E	16	-200 ~ 1000		
		4	199.9 ~ 999.9		
	T	5	-199.9 ~ 400.0		
	R	6	0 ~ 1700		
	B	7	0 ~ 1800		
	S	8	0 ~ 1700		
	L	17	-200 ~ 900		
		9	-199.9 ~ 900.0		
	N	10	-200 ~ 1300		
U	11	-199.9 ~ 400.0			
RTD	JPt100 Ω (JIS,KS)	20	-199.9 ~ 500.0		
		22	-200 ~ 500		
	Pt100 Ω (DIN,IEC)	21	-199.9 ~ 640.0		
		23	-200 ~ 640		
		24	-199.9 ~ 640.0		
Voltage (VDC/mVDC)	0~100 mV DC	33	0 ~ 100mV DC		
	-10~20 mV DC	32	-10 ~ 20 mV DC		
	1~5V DC	30	1~5V DC		
Current	4~20mA DC	30	When using current input, use the resistor 250Ω on input terminal.	When using 1~5V input (30), the interior jumper switch must be relocated.	

How to change the interior switch when using 1~5V input

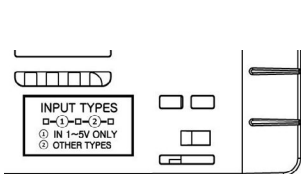

Remove the jumper cover on the underside of the T50, or remove the rear case.

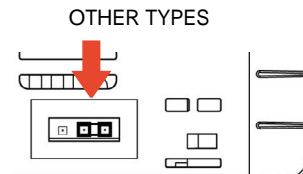

Detach the jumper using tweezers and move it to the 1 - 2 pins to the left.

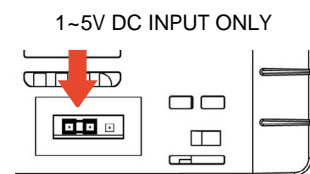

Once this has been completed, put the jumper cover back on, as shown on the picture above.

2-2. Output constitutions

K50 SERIES can use up to three different alarm outputs for 21 different types.

In addition, the unique output configuration of the system allows the user to designate the output port freely, and the alarm 1~3 outputs can be exchanged or used together.

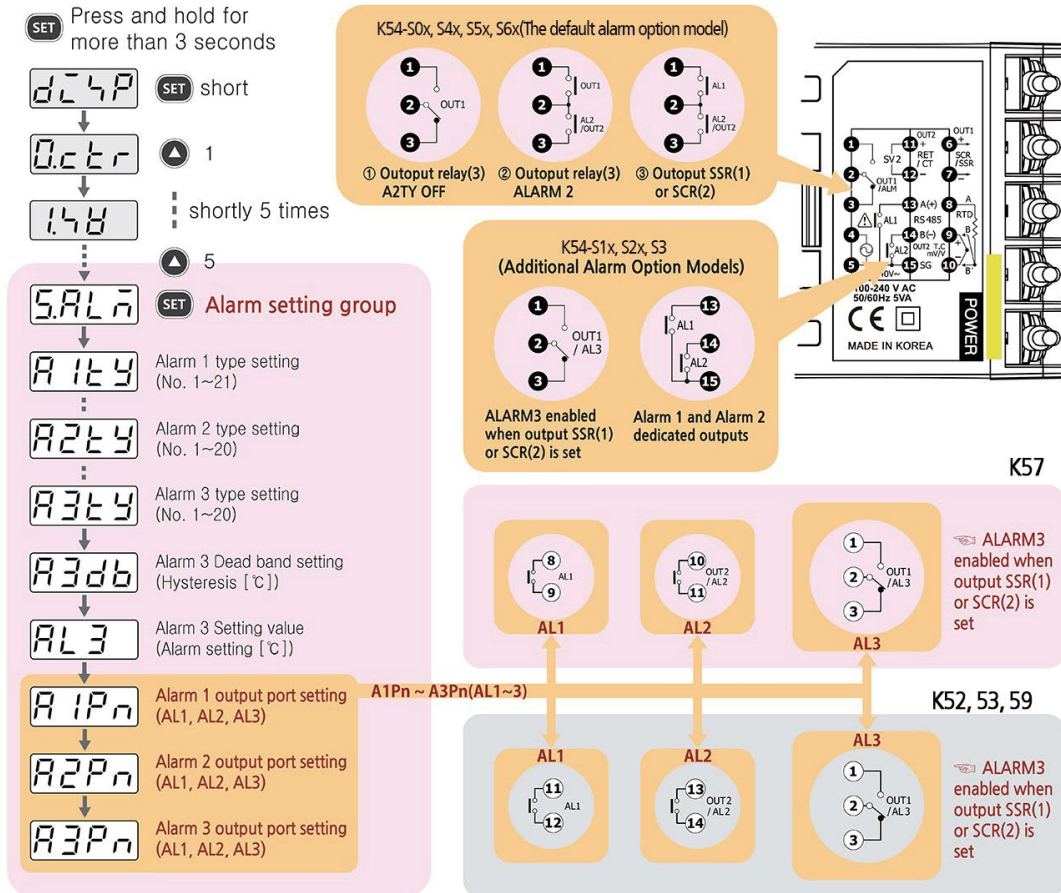

※ Detailed description related to setting of control and alarm output port

- ① Basically, the K50 series output supports a total of three event outputs, each of which consists of 21 types.
- ② Basically, alarm 1 is set to AL1 port, alarm 2 is set to AL2 port, and alarm 3 is set to AL3 port. However, if necessary, the output port can be used in combination or a single output port can be used. It provides a powerful function that can logical sum or OR the alarms 1 to 3.
 - ☞ When alarms 1 to 3 are set to one port, it is necessary to set only one of the process high and process low, or if the process high and the process low are mixed and the port is specified as one port, process high.
- ③ When the cooling output is set to RELAY (3) by selecting the heating / cooling dual control mode, the AL2 (OUT2) port is used as the cooling control output.
- ④ In case of model without alarm option of K54 (48x48mm), the main control output (①, ②, ③) port can be automatically changed to various output contact according to the setting and can be used as maximum 2 relay contact output.

2-2. Configuration of control output

Setting of heating and cooling control PID control mode

Example) Model K54-S10

K50-SERIES

SET Press and hold for more than 3 seconds

d24P **SET** short

0.ctr

9.cn

8.out **SET**

out 1 PV
SV

a.Act PV ← Selecting Output Operation (REV, DIR, DUAL)

duAL SV REV : Heating control DIR : Cooling control
Dual : Heating and cooling control

out 2 Only displayed during dual (heating and cooling) control

ct ← Cycle time in heating (output 1) SSR or relay

※ It is not used in the SCR (4 to 20 mA) mode, so it will not be displayed.

ctc ← Cycle time in Cooling (output 2) SSR or relay

※ It is not used in the SCR (4 to 20 mA) mode, so it will not be displayed.

Gco ← The cooling gain setting range can be set from 0,1 to 10,0

※ Caution!

In Heating & cooling mode, control output uses alarm 2 output, so must be change to alarm 1 or alarm 3 when using alarms.

Output selection number	Heating or cooling control (output 1)	Output terminal
0	RELAY ON/OFF control	①, ②, ③
1	SSR P.I.D control	⑥, ⑦
2	SCR (4~20mA) P.I.D control	⑥, ⑦
3	RELAY P.I.D control	①, ②, ③

※ Press and hold **SET** key for more than 3 seconds in any menus to return to Normal operation mode. After the auto tuning is completed, the entry of the input and output setting menu is automatically blocked. Please refer to the instruction manual if reset and release are required.

Use ◀ or ▼, ▲ key to adjust the setting number corresponding to the output type, and then save it using **SET** key.

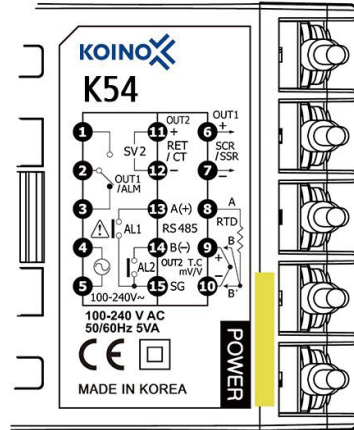

Example) Model K54-S10

Output selection number	Heating or cooling control (output 2)	Output terminal
1	SSR P.I.D control	⑪, ⑫
2	SCR (4~20mA) P.I.D control	⑪, ⑫
3	RELAY P.I.D control	⑭, ⑮

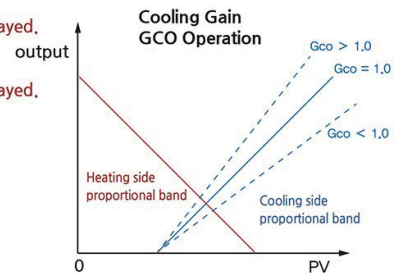

● Dead band setting : It is used only for heating / cooling control and sets the dead zone area of heating and cooling.

3.PId PID Group menu

PId Select Group (Default)

1

1.db Dead band setting (-100 ~ 100%)

※ Explanation of operation according to dead band value

The default value is set to 0,0% and does not need to be set except in special cases

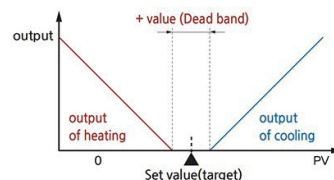
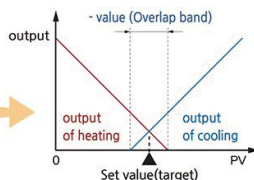

PID CONTROLLER

3. Dimensions and panel cutouts

1) K52 (48 × 96 mm) Dimensions

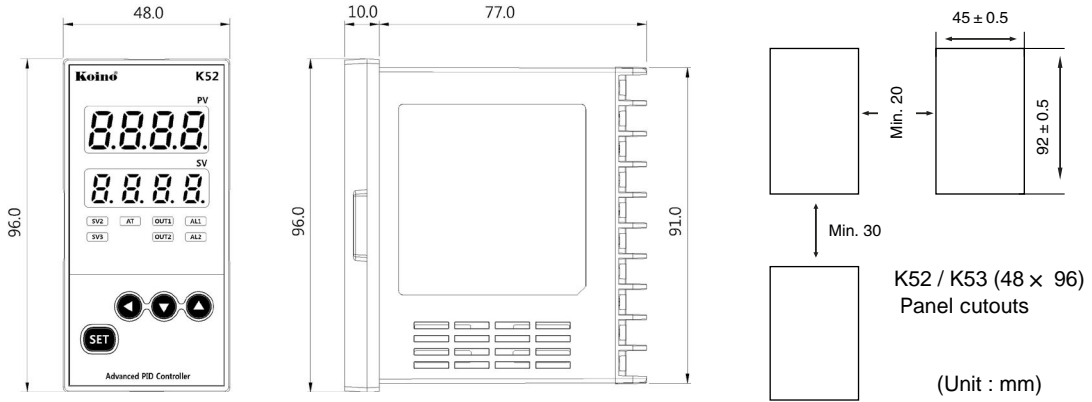

2) K53 (96 × 48 mm) Dimensions

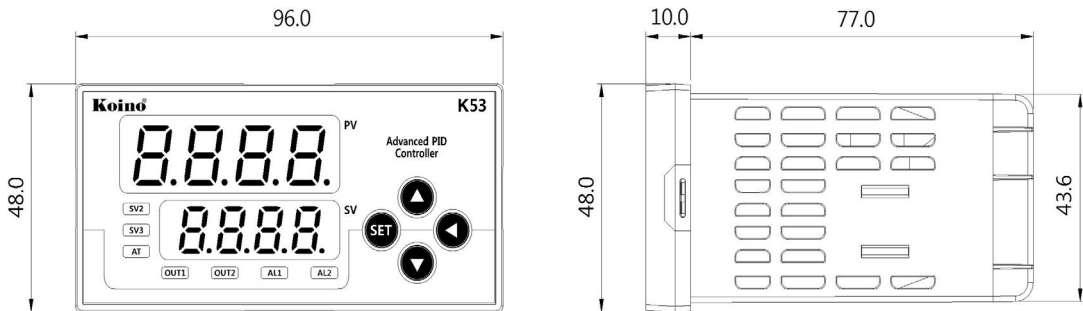

3) K54 (48 × 48 mm) Dimensions

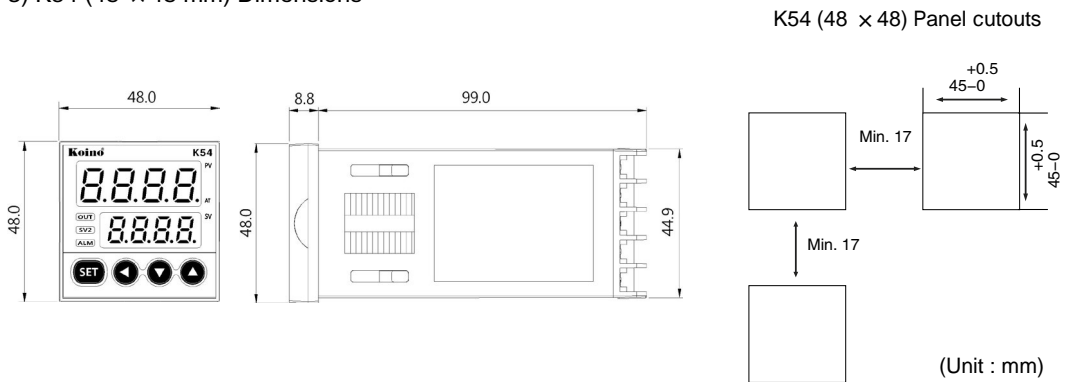

PID CONTROLLER

4) K57 (72 × 72 mm) Dimensions

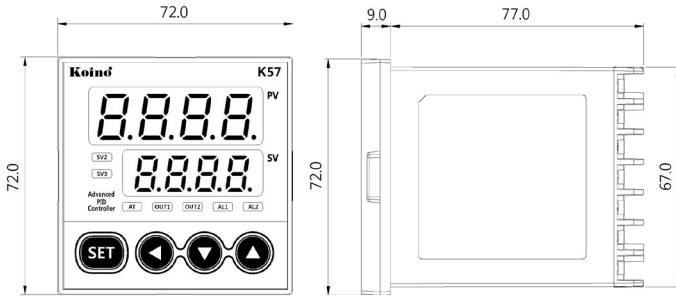

K57 (72 × 72) Panel cutouts

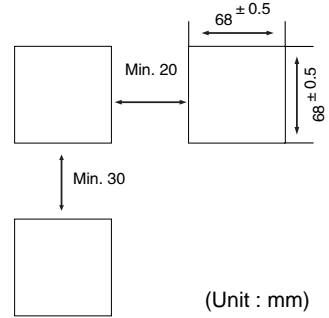

5) K59 (96 × 96 mm) Dimensions

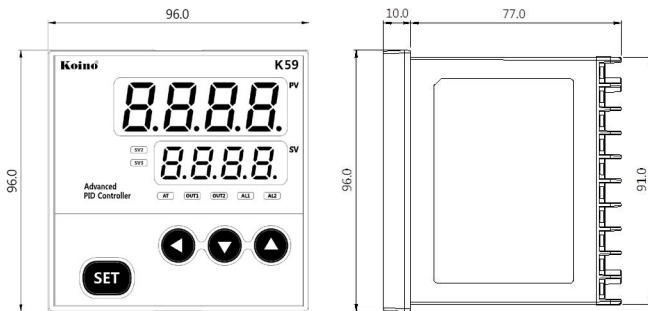

K39 (96 × 96) Panel cutouts

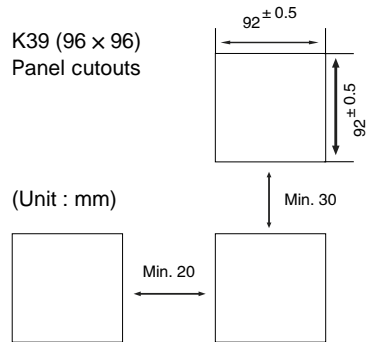

HBA option (Heater break alarm)

Current transformer (CT) : CTL-6-S or 800:1 CT use

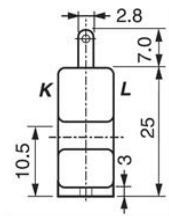
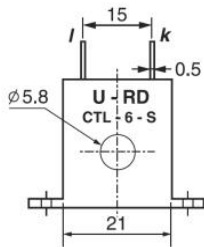

Panel cutouts

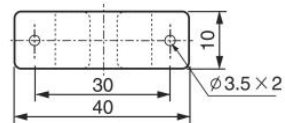

Installation

■ K54-SERIES

Bore a hole in the panel, referring to the panel cutouts on the previous page.

Insert this device into the front of the panel.

From the rear of controller, slide the bracket over the housing.

Push the bracket in until the device has been fixed securely onto the panel.

Secure using screws on the two locations at top and bottom as shown on Figure 2.

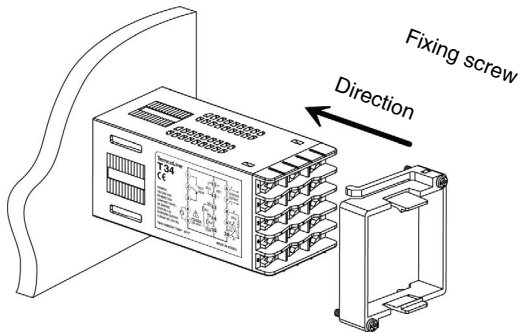

[Picture 1]

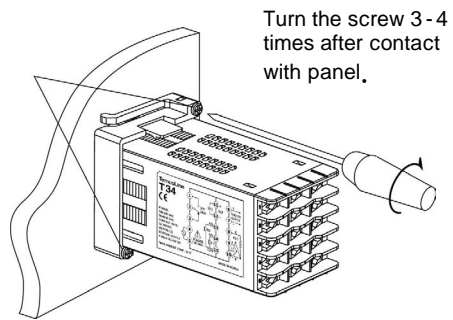

[Picture 2]

■ K52 / K53 / K57 / K59-SERIES

Bore a hole in the panel, referring to the panel cutouts on the previous page.

Insert this device into the front of the panel.

Insert 2 brackets, one each on the B/K holes on the top and the bottom of the device.

Secure using screws on the two locations at top and bottom.

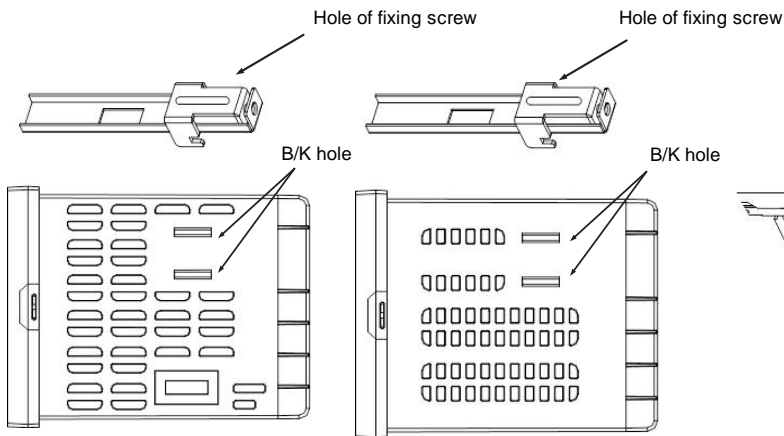

[Picture 1] Top side

[Picture 2] Bottom side

[Picture 3] Fixing completion

Turn the screw 2 - 3 times after contact with panel.

4. Terminal arrangements and wirings

1) K52 (48 × 96 mm), K53 (96 × 48 mm)

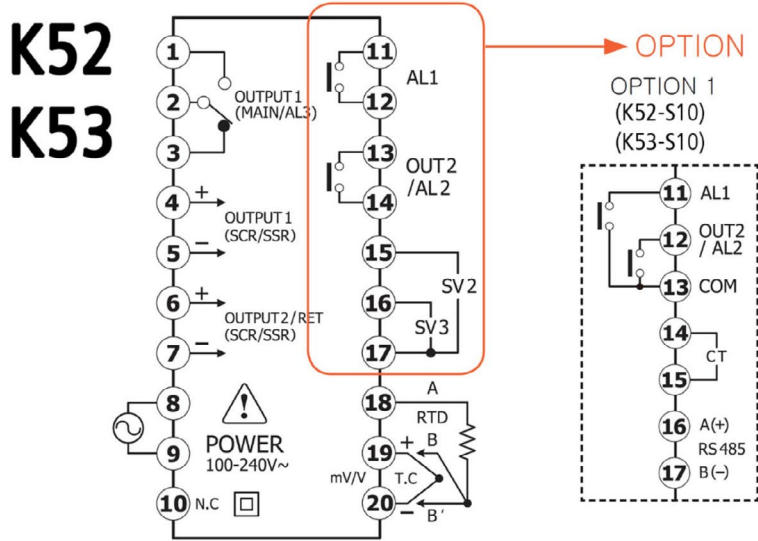

2) K54 (48 × 48 mm)

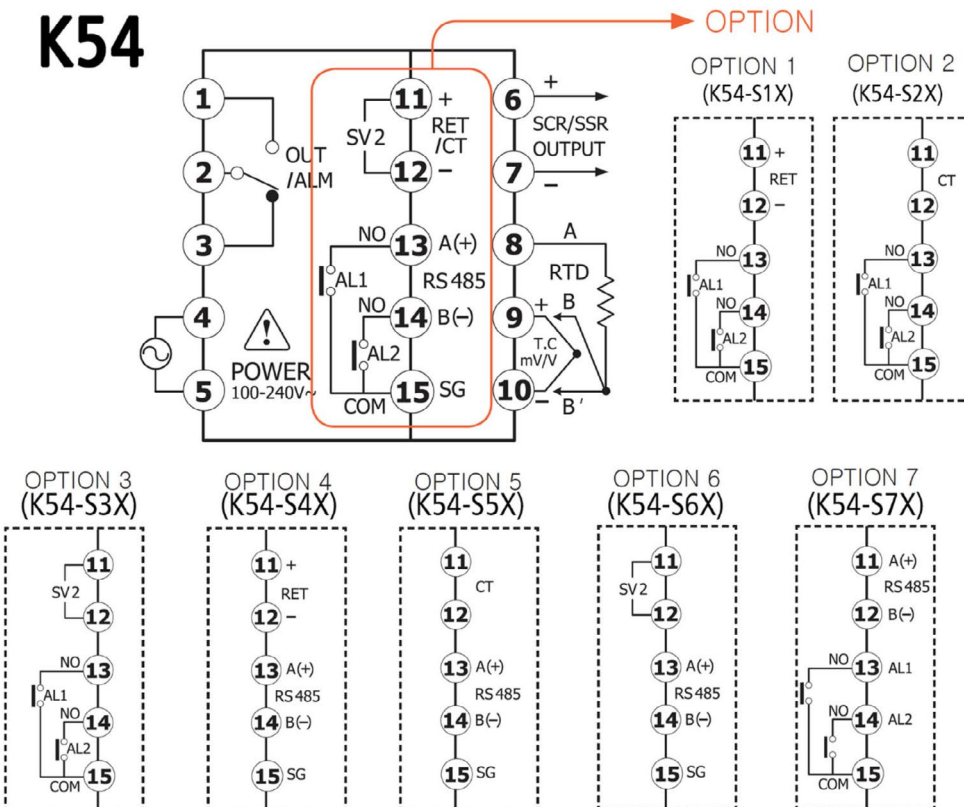

PID CONTROLLER

3) K57 (72 × 72 mm)

K57

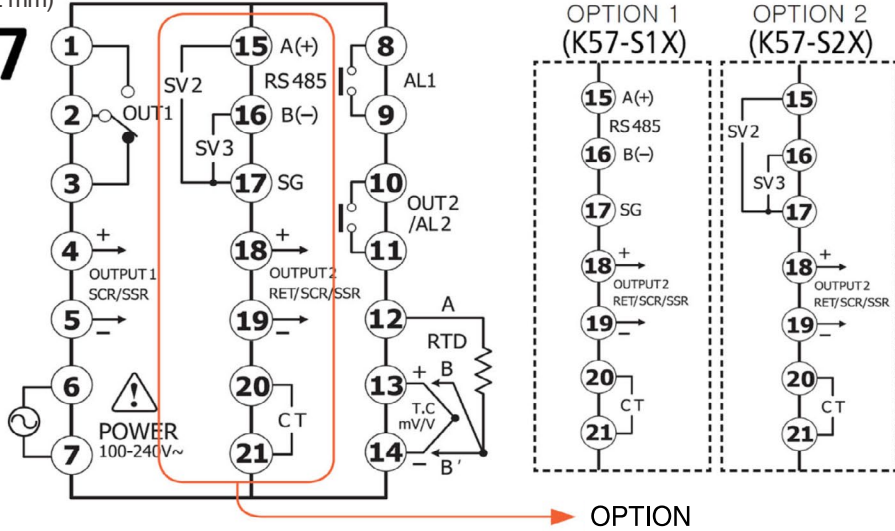

OPTION

4) K59 (96 × 96 mm)

K59

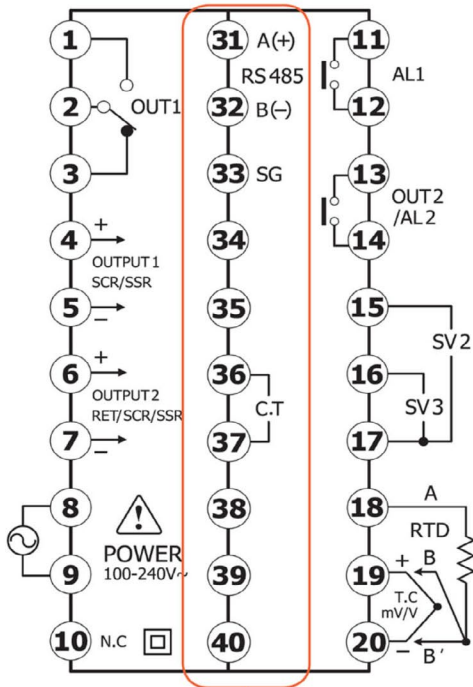

OPTION 1(K59-S1X)

Terminal explanation (K59-S10 basis)

- Terminal ① ② ③ : OUT1 only for output selection no. 0, 3 (Relay output) mode.
- Terminal ④ ⑤ : OUT2 only for output selection no. 1, 2 (SSR, SCR output) mode.
- Terminal ⑥ ⑦ : RET(Retransmission 4~20mA or for power of sensor SPS. (DC 15V)
- Terminal ⑧ ⑨ : Power supply terminal.
- Terminal ⑪ ⑫ : Alarm1 output terminal.
- Terminal ⑬ ⑭ : Alarm2 output terminal.
- Terminal ⑮ ⑯ ⑰ : The external D.I input terminal may be used when (DIS=ON), and the target value may be controlled. (SV1, SV2, SV3)
- Terminal ⑱ ⑲ ⑳ : Input terminals.
- Terminal ㉓ ㉔ ㉕ : RS-485 communication terminals completely isolated, Modbus-ASCII, Modbus-RTU, PC-Link, TL-Link basic.
- Terminal ㉖ ㉗ : C.T(800:1) input terminals for Heater break alarm.

5. Ratings and specifications

Model	K50 - SERIES	
Power supply	100~240V AC 50~60Hz (Operating voltage range 85~265V AC) 24V AC or DC (Operating voltage range 20~28V DC)	
Power consumption	6VA (Max.)	
Sensor input	Thermocouple (TC) : K, J, T, E, R, B, S, L, N, U, C(W5), D(W3) Resistance temp. detector (RTD) : KPt100(KS), JPt100(JIS), Pt100(DIN) Current input : 4~20mA DC Voltage input : 1~5V DC, -10~20mV DC, 0~100mV DC	
Accuracy	± 0.3% of FS +1Digit	
Input impedance	Current input (250 Ω), Voltage input (including TC) 1M Ω min. (RTD allowable wiring resistance : 10 Ω max., but, 3 wires have a equal resistance)	
Input sampling period	250ms (changeable according to SG - PID algorithm)	
Control output	Relay	1c 250VAC, 3A(resistive load) Electrical life 100,000 min. (PID output or ON/OFF output)
	Voltage (S.S.R)	DC15V 25mA (Built-in short protection circuit) Voltage pulse (PID output)
	Current (S.C.R)	4~20mA DC, allowable load impedance 600 Ω max. (PID output)
Control type	Super 2 degree - of - freedom PID (SG - PID algorithm), S - Fuzzy, Auto - Tuning	
Digital Input	ON : 1K Ω max., OFF : 100K Ω min. (SV1, 2, 3 external control input)	
Retransmission output	4~20mA DC, allowable load impedance 600 Ω or less. Resolution 1/4600 PV, SV, MV[%], SPS	
Alarm	ALARM1, 2	1a 250V AC 3A (Resistive load)
	HBA(C.T) com.	HBA : 1~50A AC (Resolution 0.5A)
Communication output	2 wires RS485 totally independent insulated / Max. speed : 9,600bps Max. connect no. 99 devices (32 devices recommended) Support protocol : PC - Link, TL - Link, Modbus - ASCII, Modbus - RTU	
Ambient temperature and humidity	-10~50 °C / 25~85% RH (with no condensation or icing)	
Weight (incl. B/K & accessories)	K52, K53, K57 - SERIES : 230g K54 : 140g K59 : 320g When option + 30g	

PID CONTROLLER

6. Name & Function (ex. K54-SERIES)

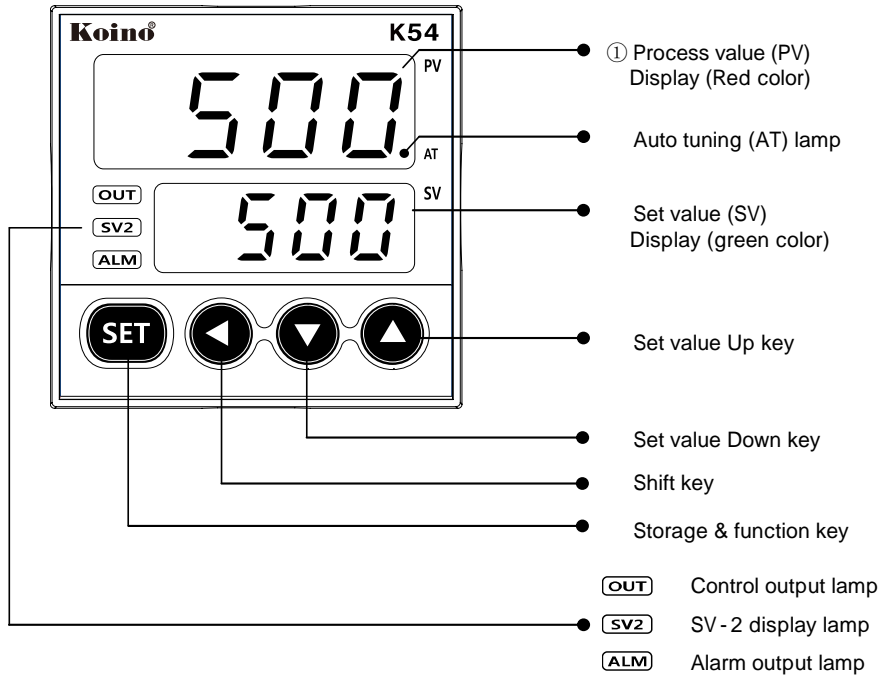

◆ Description

Name	Function
Process value	Display the process value. (red color)
Auto tuning lamp	Flash every 0.5 second during auto tuning.
Set value display	Display the set value, codes, and modes.
Control output lamp	Lights when the control output is ON.
SV - 2 display lamp	Lights when the SV 2 is displayed.
Alarm output lamp	Lights during the alarm is ON.
Function key	Use to move the menus, to store, and to operate.
Shift key	Use to shift the digits.
Set value down key	Use to decrease set value and to move the menu.
Set value up key	Use to increase set value and to move the menu.

7. Check Points before Using

1) Default values at the point of manufacture

The default input and output values of the product at the point of manufacture are as follows.

Input : K-Type (Sel. code 1) Output : SSR mode (Sel. code 1)

In the case of the basic model of K34-S00 only, when SSR(1) or SCR(2) is chosen as the output mode, Alarm 1 output will be in main relay. (Refer to page 8 for details)

2) 7 Segment display indications

A	b	c	d	E	F	G	H	I	J	K	L	ñ
A	B	C	D	E	F	G	H	I	J	K	L	M
n	o	P	q	r	s	t	u	v	w	x	y	z
N	O	P	Q	R	S	T	U	V	W	X	Y	Z

3) Initial display on power supply (K54-SERIES basis)

The diagram shows the K54 PID controller display with the following labels and legends:

- Model Name:** Koino K54
- Option indication:**
 - 0 : Basic type (No option)
 - 1 : RET, ALARM1, 2
 - 2 : HBA(CT), ALARM1, 2
 - 3 : DI(SV1, 2), ALARM1, 2
 - 4 : RET, RS-485
 - 5 : HBA(CT), RS-485
 - 6 : DI(SV1, 2), RS-485
- Output type indication:**
 - 0 : RELAY ON/OFF control
 - 1 : SSR (VOLT-PULSE) PID control
 - 2 : SCR (4~20mA) PID control
 - 3 : RELAY PID control
- Input type indication:**
 - 01 : K-Type (-200~1370)
 - 02 : K-Type (-199.9~999.9)
 - 33 : mV DC (0~100mV)
- Firmware version display:** 540.1

The display also shows PV (540.1), AT, and SV (09.01) values, along with buttons for SET, SV2, ALM, and navigation arrows.

8. Initial installation and minimum operation procedures

The following are the instructions for initial installation and minimum operation procedures.

Please read the contents of this manual, including the general functions outlined here, as thoroughly as possible before operating the device.

1) Check the external wiring diagram and specifications

(power supply and terminal arrangement)

2) Check input and output specifications!

The default setting for the K50 series at the point of manufacturer are as follows.

Input : K(CA) Type (setting code 1)

Output : SSR mode (setting code 1)

If you wish to change the input or the output type, please select the option you desire on the input group and the output group menus.

The input type settings must be configured first before changes to other set values are made.

When the input type is changed, all other parameters (set values) are reverted to their factory default.

3) Select the desired set value (SV).

4) Please set auto-tuning or P, I, D values to suit the operating environment.

Auto-tuning is recommended except under special circumstances

To ensure safety and prevent wrong operation, once auto-tuning has been completed, "level-2" (setting menu display limit) will be set automatically.

At the same time, setting menu output group(8.out) and input group(9.in) are not displayed.

If needed reset, please change to "level-3"(setting menu display limit)and operate.

Please refer to the "3) setting menu display limit" at page 22.

9. Entering into "set menu" and Setting method

1) Input & Output type setting



products are universalized input and output.
Please set up input and output type firstly and use when install our unit.

SET more than 3 sec.

dLrP

LEVEL
3
When it is LEVEL 3, input/output set is available.
Setting menu display limit (LEVEL) function

SET Press once shortly
Q.c.t.r

Press once short

g.Ln **SET** L.nP

Input type setting: Select the desired input sensor type.
(setting code 1~33/ refer to Input ranges)

i
u.n.c.t
SET
b.o.u.t

INPUT(T.C)	CODE	TEMP. RANGE	INPUT(RTD)	CODE	TEMP. RANGE
K	1	-200 ~ 1370	JPt100Ω (JIS, KS)	20	-199.9 ~ 500.0
	2	-199.9 ~ 999.9		22	-200 ~ 500
J	15	-200 ~ 1000	Pt100Ω (DIN, IEC)	21	-199.9 ~ 640.0
	3	-199.9 ~ 999.9		23	-200 ~ 640
E	16	-200 ~ 1000			
T	4	-199.9 ~ 999.9	INPUT(V DC/mV DC)		CODE
	5	-199.9 ~ 400.0	0~100 mV DC		33
R	6	0 ~ 1700	-10~20 mV DC		32
B	7	400 ~ 1800	1~5 V DC		30
S	8	0 ~ 1700	4~20mA DC (Use 250Ω resistor)		
	L	17	-200 ~ 900		
N	9	-199.9 ~ 900.0			
	10	-200 ~ 1300			
U	11	-199.9 ~ 400.0			
C (W5)	12	0 ~ 2300			
D (W3)	13	0 ~ 2400			

Press once shortly

B.o.u.t

SET Press once shortly

o.u.t

Output type setting: Select the desired output type.

i

SETTING CODE	CONTROL OUTPUT
0	RELAY ON/OFF CONTROL
1	SSR P.I.D CONTROL
2	SCR (4~20mA) P.I.D CONTROL
3	RELAY P.I.D CONTROL

a.R.c.t

SET

oL-L

If the P value is set to OFF even when the P.I.D control out put 1,2, or 3 is selected, it operates in the ON/OFF mode.

PID CONTROLLER

2) Set value(SV) setting [in condition of Mvn= OFF(basic)]



- ① Enter to setting mode by **SET** key
- ② Set a desired value by **←** **↓** **↑** key
- ③ Store a value by **SET** key



AT operation start: **SET** + **↑** 0.5 second

AT stop by perforce: **SET** + **↑** 0.5 second

AT command lamp (flash every 0.5 sec.)

Auto-tuning is required before operating for the first time. Set the target value(SV) in the range mainly used and run auto-tuning. When auto-tuning begins, the "auto-tuning command lamp" will flash every 0.5 second and will turn off upon completion of the auto-tuning process. Please refrain from operating the keys while auto-tuning is in progress.

※ Function of menu return

If you press the up key while pressing the set key in any setting menu, you can move to the corresponding upper menu and move to the desired menu immediately.

※ Useful Features

- ※ Use the menu return function to speed up the setting up to 10 times faster.

10. Flow Chart (Parameter structure)

〈 Basic drive menu 〉

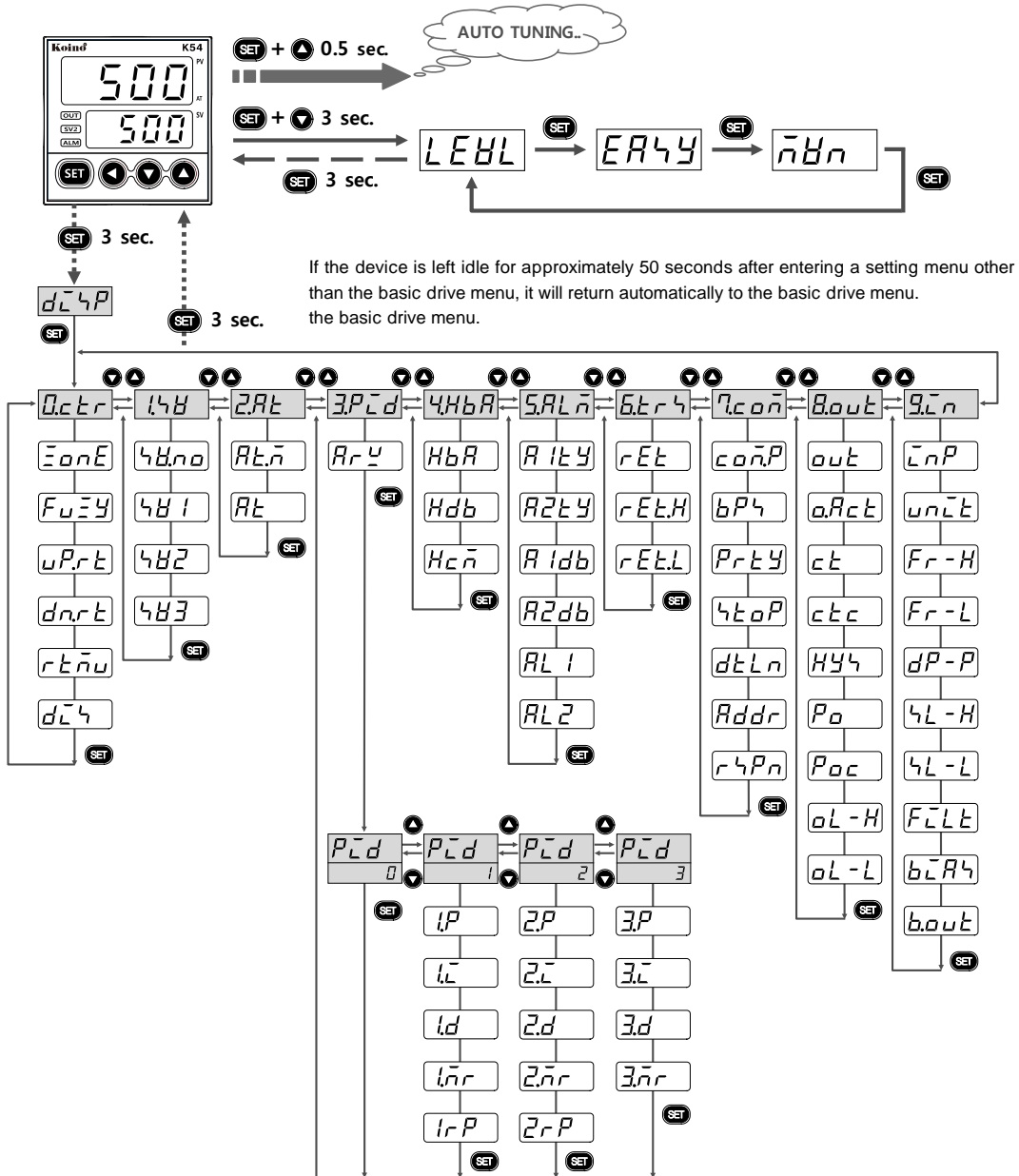

The full menu diagram above shows all control and setting menus on the K50 series, but during actual operations the menus that are the most relevant to the situation according to the options and the drive mode, providing a simpler user interface while retaining functionality.

11. Easy function & Safety function

1) Easy Menu

“ Easy Menu ” is displays the most frequently used functions of the K50 series, and hides the others.

〈 Setting method 〉

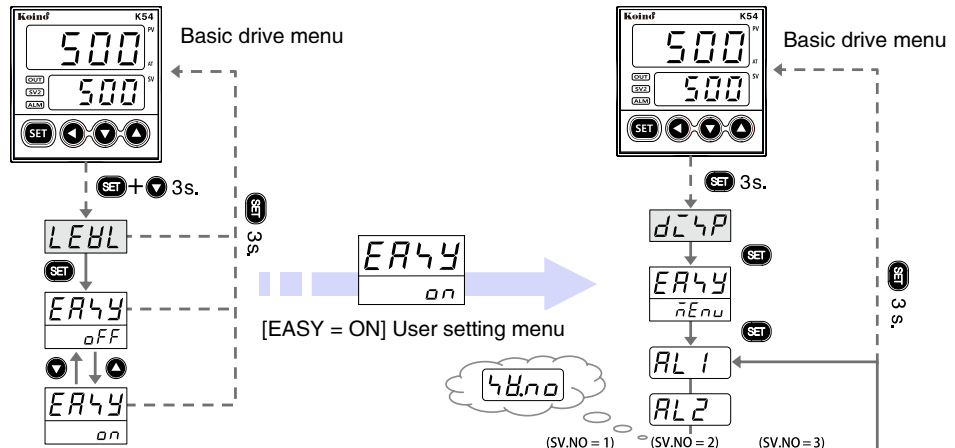

2) Control output[%] (Mvn) check mode

“ Mvn [%] check function ” displays the control output [%], which can be viewed by pressing the “ SET ” key while operating in default drive mode and is shown as a percentage of the control output (0~100[%]) in the SV display.

In this mode, pressing the “ SET ” key alternates between showing the SV and the Mvn values, and changes to the SV value can be made by “ \downarrow ” or “ \uparrow ”.

If required, set in the order of \leftarrow \rightarrow SET .

〈 Setting method 〉

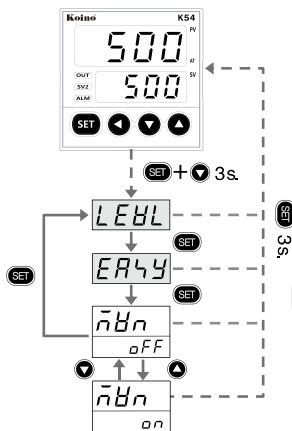

〈 In condition of Mvn=ON 〉

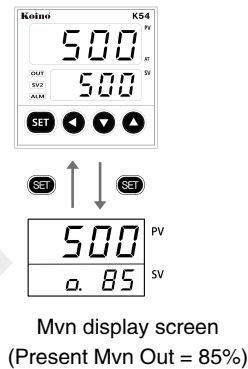

3) Setting menu display limit (LEVEL) function

The setting menu display limit function limits the range displayed according to the level set in the control and the setting menus in the K50 series. This can be used, for example, to prevent user's miscontrol after all settings have been configured.

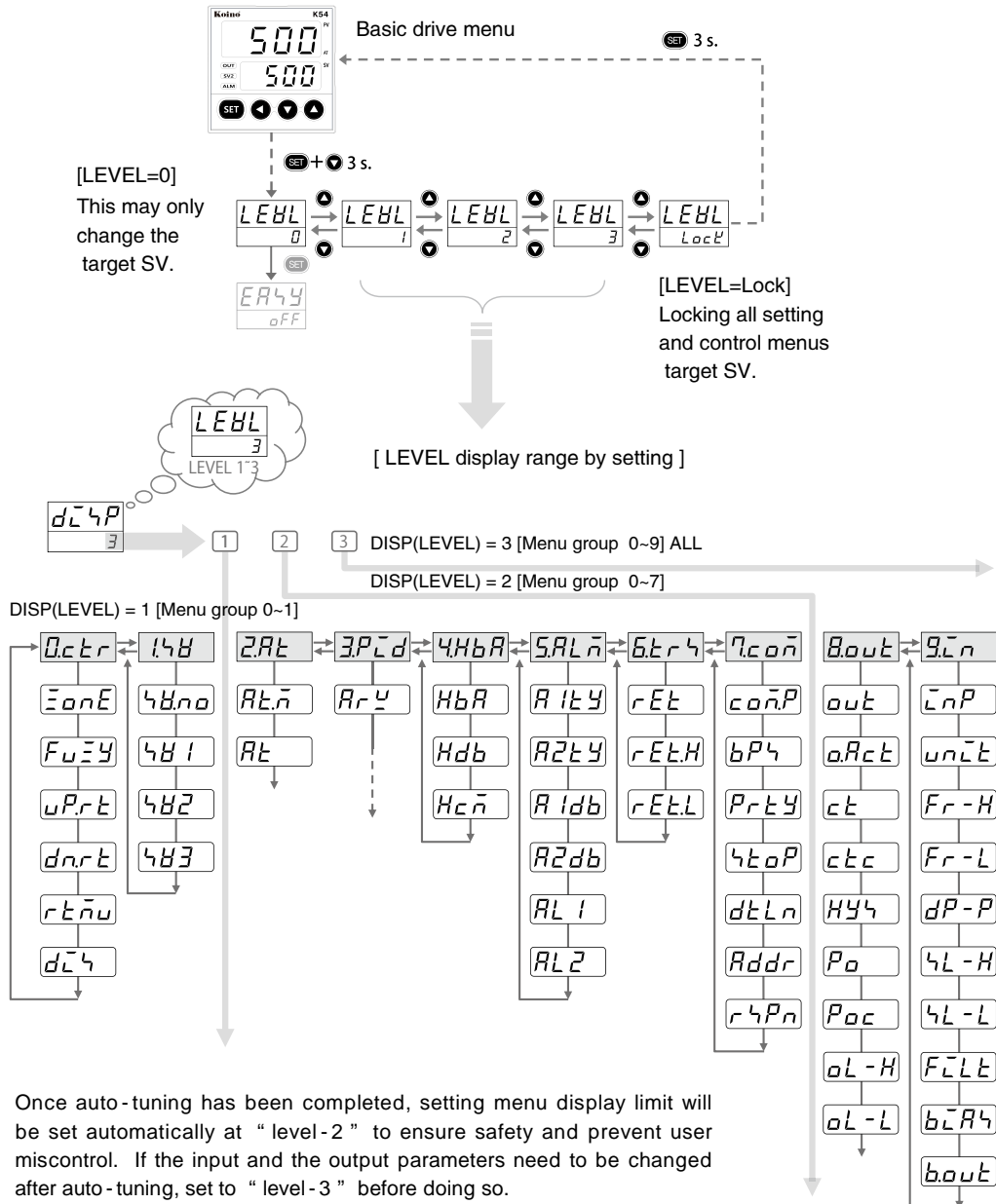

12. Functions of each setting group

[0] Control group setting

Control zone, fuzzy function, and ramp function may be selected, and the fuzzy function works only in PID control mode. In addition, as shown in Table 1, the 3 set values (SV1, SV2, SV3) preset by the two external contact inputs may be selected and controlled

Display	Description	Setting range	Condition	Initial value
	Enter to control group			
	Control zone selection	OFF / ON	Always	OFF
	Fuzzy function selection	OFF / ON	PID control	OFF
	Initial rising temp. setting (Ramp function)	OFF / EUS (0 ~ 100 %)	Always	OFF
	Initial drop temp. setting (Ramp function)	OFF / EUS (0 ~ 100 %)	Always	OFF
	Time (Hour/Minute) unit selection (Ramp function)	HOUR / MIN	Always	HOUR
	External contact input ON/OFF switch	OFF / ON	D I option	OFF

※ EU : An engineering unit in compliance with the input range

ex) Input selection no. : 01 (K - TYPE)

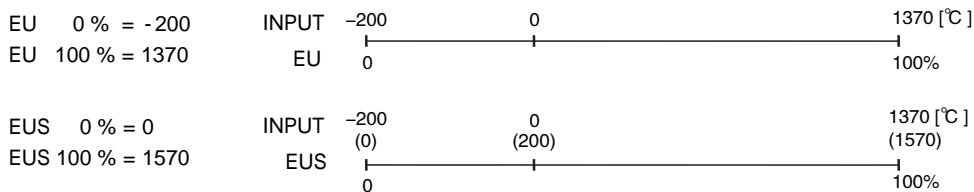

1) Digital input switch (DIS): This function selects whether to use direct input switch.

Please use a non-voltage contact (relays, switches) for direct input. If a non-contact device such as a semiconductor are used, please operate within the ranges
ON = under 1K , OFF = over 100K .

Target set value on External contact input (DIS=ON)

DIS selection	SV selection mode by external contact signal		
OFF	No external contact signal		
ON	external signal	SV2	SV3
	Display selection	OFF	OFF
	Display the SV1	ON	OFF
	Display the SV3	ON	ON

2) Control zone (ZONE): In an environment with large temperature fluctuations, the optimal PID value may vary according to the temperature range. This function allows 3 separate temperature ranges to be set in order to control the PID value in each of them.

3)Fuzzy : The K54 series is equipped by default with an S - PID unique to Temcoline, and separate fuzzy or ARW functions are usually not required, so this can be kept off most of the time.

Use under special circumstances or when external disruptions cause repeated

PID CONTROLLER

4) Ramp function : This controls the incline toward the initial set values (SV1, SV2, SV3). To use this function, set the time at the initial temperature increase and decrease settings, or define the desired initial temperature increase or decrease per hour or minute. Once this has been set, a steady incline from the starting temperature to the set values will be maintained.

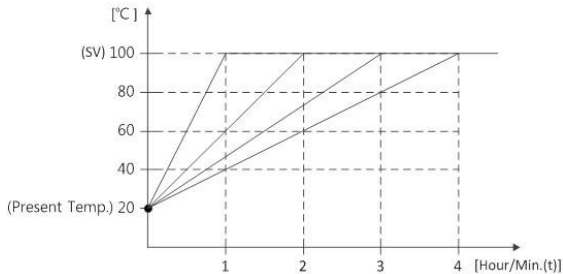

For example,
when the desired SV is set as 100 , the initial temperature increase as (UP.RT) 20 , and the time unit (RTMU) as in minutes, the incline to the SV will be at 20 per minute.

← Refer to left graph!

[1] Set value(SV) group setting

With the SV group, the 3 control set values (SV1, SV2, SV3) must be set before they can be selected and controlled as desired by direct input signal or by the internal menu.

In the case that direct input signal is used to control, the direct input switch (DIS) must be on. If the switch is off, the selection will be made by the set value number(SV no).

Display	Description	Setting range	Condition	Initial value
1.48	Enter to set value setting group			
48.no	Set value number selection	1 / 2 / 3	Always	1
481	Set value 1 (SV1) setting	EU (0.0 ~ 100.0 %)		EU (0.0%)
482	Set value 2 (SV2) setting	EU (0.0 ~ 100.0 %)		EU (0.0%)
483	Set value 3 (SV3) setting	EU (0.0 ~ 100.0 %)		EU (0.0%)

[2] Auto tuning(AT) group setting

Before the PID temperature controller can be used for the first time, the P, I, D values must be tuned. The auto-tuning function finds the optimal value by tuning automatically according to the load factor and other conditions.

Please make sure that the controller is tuned before using it for the first time, by defining the set values in the most frequently used range and running auto-tuning. When auto-tuning begins, the " auto-tuning command lamp " will flash every 0.5 second and will turn off upon completion of the tuning process. Please refrain from operating the keys while auto-tuning is in progress. The K50 series is able to perform several kinds of auto-tuning.

To make auto-tuning easier, the Quick-AT function, which allows the command to be executed with a simple external key combination.

PID CONTROLLER

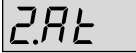
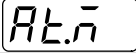
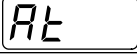



Display	Description	Setting range	Condition	Initial value
	Enter to auto tuning		PID control	
	Auto tuning (AT) type selection	Standard / Low	PID control	STD
	Auto tuning (AT) start selection	OFF / 1 / 2 / 3 / Auto	PID control	OFF

This product performs optimally when auto-tuning is executed in the STD mode according to the S-PID algorithm. We recommend that you operate the product in the STD mode.

- 1) Types of auto-tuning (AT) : The K50 temperature controller has two tuning methods, standard auto-tuning (STD; based on the set value) and low - SV tuning (LOW: SV - 10%). Under normal conditions, the standard auto-tuning is recommended.
- 2) Start auto-tuning : This menu starts the auto-tuning process. Select the number of the SV that you wish to tune (SV1 " 1 ", SV2 " 2 ", SV3 " 3 "), and auto-tuning will begin, making automatic calculations which will be stored under the P, I, D values of the corresponding SV.
When set on AUTO,
SV1~3 will be auto-tuned consecutively if in the control group ZONE is set as off. If ZONE is on, groups 1, 2, and 3 will be created based on the ranges set in 1RP and 2RP of the PID group, and the results will each be stored under the PID groups 1, 2, and 3.

[3] P.I.D group setting

This is used to view the PID and ARW values produced by auto-tuning in the auto-tuning groups, and to change the values manually.

- 1) In the PID selection group, press the "  " key to set automatically or manually the anti-reset wind-up ARW value. Pressing again the "  " key will display the PID selection mode, where you may choose to view the group PID parameters by selecting 0~3.
For example, when " 0 " is selected in the PID mode, no PID values will be shown. Use the "  " key to select " 1 " and then press the "  " key to view the PID values for group 1. Selecting " 2 " and " 3 " will display the values for groups 2 and 3 respectively. (This is intended to prevent accidentally mishandling the settings)

- 2) Manual reset (MR) is displayed when the integral value set at OFF, and it is used to manually remove control offsets.
- 3) When the control group zone selection mode is on, 2 zone location settings may be made to control 3 zones.
- 4) The " n " in the table next page indicates that the number may be from 1 to 3.

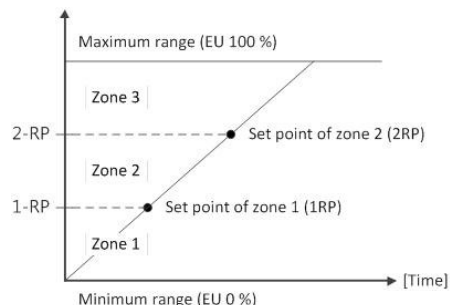

This product provides optimal control when ARW is in automatic mode according to the S-PID algorithm. We recommend that you used the product in the automatic mode.
The ARW function is actually seldom required with S-PID.

PID CONTROLLER

Display	Description	Setting range	Condition	Initial value
	Enter to P.I.D setting group		PID control	
	Anti Reset Wind - up setting	Auto / 50.0 ~ 200.0 %	PID control	AUTO
	P.I.D group selection	0 / 1 ~ 3	Always	0
	n. Proportional (P)	0.1(D - TYPE : 0.0) ~ 999.9 %	PID group selection	3.0 %
	n. Integral time (I)	OFF / 1 ~ 6000 sec.	Always	240 sec.
	n. Differential time (D)	OFF / 1 ~ 6000 sec.	Always	60 sec.
	n. Manual reset (M.R)	- 5.0 ~ 105.0 %	Integral time OFF	50.0 %
	n. Proportional band of cooling side (P)	0.0 (ON/OFF control) / 0.1 ~ 999.9 %	Heating/Cooling type	3.0 %
	n. Integral time of cooling side (I)	OFF / 1 ~ 6000 sec.	Heating/Cooling type	240 sec.
	n. Differential time of cooling side (D)	OFF / 1 ~ 6000 sec.	Heating/Cooling type	60 sec.
	n. Hysteresis band	- 100.0 ~ 50.0 %	Heating/Cooling type	3.0 %
	n. Zone position setting	EU(0) 1.RP 2.RP / EU(100.0 %)	ZONE=ON	EU(100.0 %)

Hold FUNCTION

when the low limit alarm is used. when the power is turned on and the temperature rises. unnecessary low limit alarm occurs during the rise. When the hold function is enabled. the low alarm can be ignored until the alarm set value is released once the initial power is turned on.

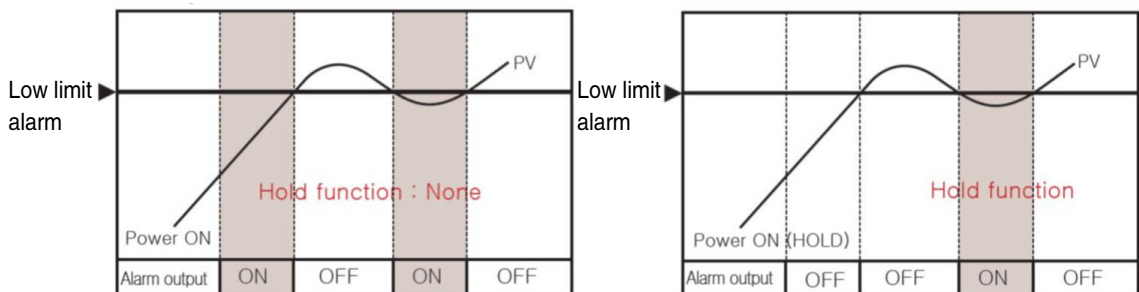

PID CONTROLLER

[4] Heater Ammeter and HBA(Heater Burnout Alarm) Setting Group

K50 SERIES supports instrument - level precision AC ammeter. It supports real - time AC current monitoring and HBA(heater break alarm) function of 0.1~38.0 A maximum. In normal operation mode, heater current can be monitored at the same time as current temperature.

SET Press and hold for more than 3 seconds.

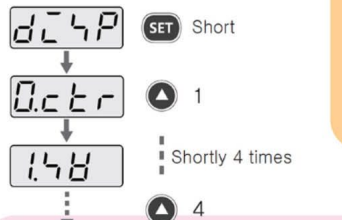

SET HBA Setting group

HbA Current setting of heater break alarm (OFF ~ 40.0A)

Hdb Hysteresis setting of heater break alarm (0.0 ~ 20.0A)

Hb5 Heater break alarm start point setting (0 ~ 100% / output When setting SCR (#2))

H.CA Heater Current Monitor (AC 0.1 ~ 38.0A)

H.Adj Heater current compensation (CT tolerance compensation) (-10.0 ~ 10.0A)

H.Hld Heater current monitoring HOLD function(ON/OFF)

H.Evt Activation for current monitoring at Normal operation mode

< Normal operation menu >

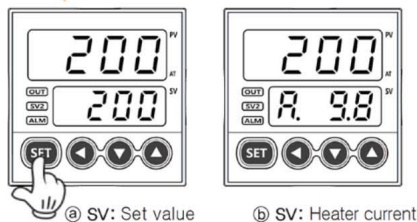

• **H.Evt** When the external current monitoring function is enabled, the heater current can be checked from the normal operation menu in real time, just like the current temperature.

• **H.Hld** Enables current monitoring for normal operation menu.
Hb5 Enables control output for normal operation menu.

K54-S2X, S5X (HBA OPTION MODEL)

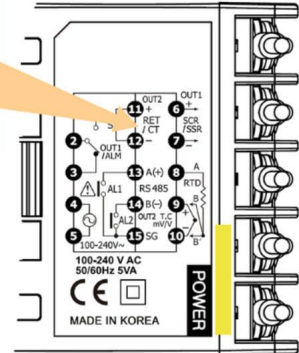
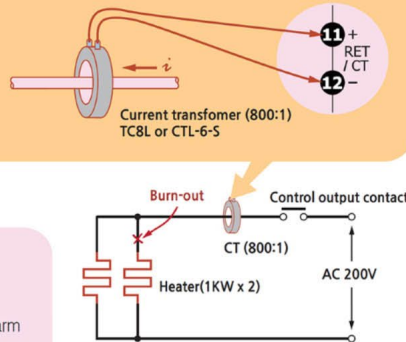

① HBA(heater break alarm) current setting procedure is as follows

$$\text{HBA Setting value} = \frac{\text{Normal current value} + \text{burn-out current}}{2} = \frac{10\text{A} + 5\text{A}}{2} = 7.5 [\text{A}]$$

② Hdb(Heater break alarm Dead band or hysteresis): This function is to prevent malfunction when the current change approaches or exceeds the set value.

$$\text{Hdb Setting value} = (\text{maximum current} - \text{minimum current}) \times 1.4$$

However, it is not applicable when the control output SCR (2) is used.

③ Hb5(Heater break alarm start point setting): Displayed only when control output (3) is used. Set when using power control element such as TPR.

$$\text{Hb5 Setting value} = \text{target setting value(SV)} \times \text{Control output during convergence(MVn)} \times 0.3$$

※ In case of heater break alarm, A1TY (Alarm 1 type set) must be set to 21 to use.

④ H.[A](Heater current monitor): The AC current flowing in the current heater is accurately measured and displayed at 0.1 to 38.0 A. When "H.EXT" is turned ON, the SV display window of the normal operation menu is displayed in real time.

⑤ H.Adj(Heater current compensation): Calibration is possible when using a different ratio of CT than the current detector tolerance or 800: 1.

$$\text{H.Adj correction value} = \frac{38 \text{ A}}{\text{Measured value}} \times \text{Measurement deviation}$$

For example, assuming a current of 10A is displayed at 9.8A,

$$\text{H.Adj correction value} = \frac{38 \text{ A}}{9.8 \text{ A}} \times 0.2 \text{ A} = 0.775 \approx 0.8 \text{ A}$$

⑥ H.Hld(Heater current hold): The output when the control output is used by SSR (1) or Relay (3) is output in time division. At this time, it is very difficult to read the instantaneous current value. Therefore, the last measured current value can be temporarily held and the correct current value can be measured at any time.

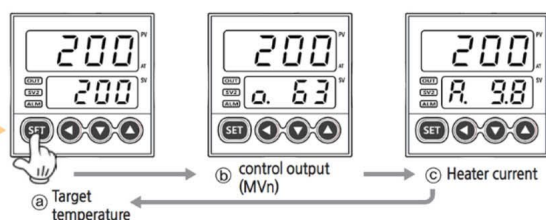

[5] Alarm (Alarm 1, 2) group setting

The K50 series has two separate alarm outputs, and in the setting group, alarms may be chosen among 21 types, and the dead band (hysteresis) for the alarm output may be set.

Please find the alarm code with the desired function in the “ Alarm types and codes table ” on the next page and use it to set the alarm output type in the settings mode.

Display	Description	Setting range	Condition	Initial value
	Enter to alarm setting group		Always	
	Alarm 1 output selection	OFF / 1 ~ 21	Always	1
	Alarm 2 output selection	OFF / 1 ~ 20	Always	OFF
	Alarm 3 output selection	OFF / 1 ~ 20	Always	OFF
	Hysteresis of alarm 1 output	EUS (0.0 ~ 100.0 %)	When using Alarm 1	1
	Hysteresis of alarm 2 output		When using Alarm 2	1
	Hysteresis of alarm 3 output		When using Alarm 3	1
	Alarm 1 output value setting	PV alarm, Deviation alarm EU (- 100.0 ~ 100.0 %)	When using Alarm 1	EU (100.0%)
	Alarm 2 output value setting		When using Alarm 2	0
	Alarm 3 output value setting		When using Alarm 3	0
	Setting of the first alarm output port	AL1 / AL2 / AL3	When using Alarm 1	AL 1
	Setting of the second alarm output port	AL1 / AL2 / AL3	When using Alarm 2	AL 2
	Setting of the third alarm output port	AL1 / AL2 / AL3	When using Alarm 3	AL 3

The HBA will be generated through alarm output # 1 (when A1TY = 21).
This means that HBA may be set only through alarm output #1 .

PID CONTROLLER

Alarm output type and Selection code

Code no.	Alarm type	Alarm output operation
01	Absolute value upper-limit	<p>When temperature is falling: OFF → ON</p> <p>When temperature is rising: OFF → ON</p> <p>Temperature: OFF → Alarm setting value → ON</p>
09	(Inverted output)	
11	with Hold function	
19	with hold function (Inverted)	
02	Absolute value lower-limit	<p>When temperature is falling: ON → OFF</p> <p>When temperature is rising: ON → OFF</p> <p>Temperature: ON → Alarm setting value → OFF</p> <p>Hysteresis: OFF</p>
10	(Inverted output)	
12	with Hold function	
20	with hold function (Inverted)	
03	Upper-limit deviation	<p><Negative temp. value setting></p> <p><Positive temp. value setting></p>
05	(Inverted output)	
13	with hold function	
15	with hold function (Inverted)	<p><Negative temp. value setting></p> <p><Positive temp. value setting></p>
04	Lower-limit deviation	
06	(Inverted output)	
14	with hold function	
16	with hold function (Inverted)	
07	Upper & Lower - limit deviation	
17	Upper & Lower - limit deviation with hold	
08	Upper & Lower - limit deviation in range	
18	Upper & Lower - limit deviation in range with hold	
21	Heater break alarm (HBA1)	Refer to HBA ! (ALARM1 only)

When alarm type reverse - correspondence is selected for alarm type and code, please be aware that when the alarm lamp turns on, the contact output will be off.

Example of Alarm output 1 setting

A1t4 Alarm type (Upper - limit deviation) = 03

A1db Hysteresis (Dead band) = 2

AL1 Alarm setting value = 20

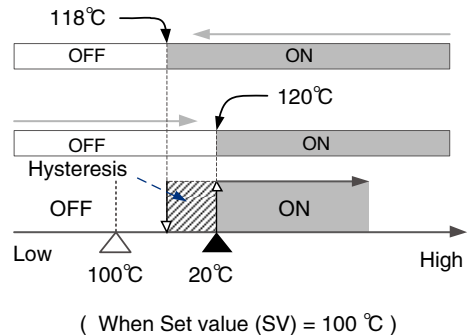

PID CONTROLLER

[6] Retransmission group setting

In the retransmission output mode, process value (PV), set value (SV), output amount (MV), or sensor power supply (SPS) may be chosen, and the output will be generated in direct current of 4~20mA. (SPS is DC15V/25mA)

Display	Description	Setting range	Condition	Initial value
	Enter to retransmission setting group		Option	
	Retransmission type or SPS selection	PV / SV / MV / SPS	Option	PV
	Highest limit of retransmission	TC or RTD : Fr-H~Fr-L Voltage : SL-H~SL-L (But, RET.H RET.L)	PV or SV selection	EU (100.0%)
	Lowest limit of retransmission			EU (0.0%)

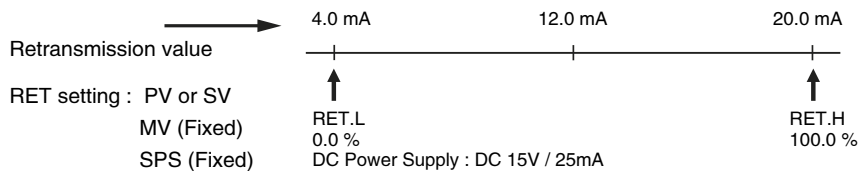

[7] Communication group setting

Display	Description	Setting range	Condition	Initial value
	Enter to communication setting group		Optional	
	Protocol selection (PC - Link, TL - Link, Modbus)	HSTD / HSUM / H - TL MODA / MODB		H - TL
	Baud rate selection (B.P.S)	600 / 1200 / 2400 / 4800 / 9600 [BPS]		9600 BPS
	Parity check selection	NONE / EVEN / ODD		NONE
	Stop bit selection	1 - bt(bit) / 2 - bt(bit)		1 - bt
	Data Length selection	7 - bt(bit) / 8 - bt(bit)		8 - bt
	Address selection	1 ~ 99 (Max. 32 devices)		1
	Response time selection	0 ~ 10 (Response time = Handling time + Response time) × 10ms		1

The K50 series has a totally insulated input - output structure.

A maximum of 32 devices may be connected to it, but this number may vary according to the site and the line conditions.

1) Communication protocols in detail

■ HSTD / HSUM

PC - Link is used by some in Korea, developed by 2 corporations.

■ H - TL (TL - Link)

This is Koino ' s own protocol.

The multi - remote surveillance program, which is included in the optional communications package for the K50 series, uses this protocol. (For the reference, this program has advanced recording functions)

■ MODA (Modbus - ASCII)

This ASCII - based protocol is commonly used in the industry, and is easy to use.

■ MODB (Modbus - RTU)

This binary - based protocol is the most widely used standard protocol in the industry, and has a high speed.

2) Modbus protocol and K50 series

The Modbus communication protocol function code in the K50 series is comprised of a function code that reads and writes D - REGISTER, and another that searches for Loop - Back.

For more information, please refer to the separately distributed Koino protocol, or contact us by our website or our customer service center

[Modbus protocol support code]

Code	Description
03	D - REGISTER consecutive READ
06	Single D - REGISTER WRITE
08	DIAGNOSTICS (LOOP - BACK TEST)
16	D - REGISTER consecutive WRITE

The Modbus support device uses as address #400001~400999 in the 16-bit holding register range, which includes 400001~465536.

When using a touchscreen for interface, the read/write addresses must be set at 400001 (D-Reg. 000) ~ 400700 (D-Reg. 699) for Pro - Face products.

For EasyView products, the device setting must be at 4x (16-bit), and the address at 001 (D-Reg. 000) ~ 700 (D-Reg. 699).

- Function Code 03 : The device is capable of reading up to 32 consecutive D - Register contents.
- Function Code 06 : The D - Register contents can be edited one at a time.
- Function Code 08 : This can be used for self - diagnosis and testing purposes.
- Function Code 16 : The device is capable of writing up to 32 consecutive D - Register contents.

In Modbus communication, the address will be designated as the real communication frame address +1. This is because the user may choose addresses from #400001 onward. (Example: #400001 = D - Reg. 000)

3) Modbus communication setting

■ Modbus - ASCII

COM.P : MODA, BPS : 9600, PRTY : EVEN, STOP : 1 - BT(bit), DTLN(Fixed) : 7 - BT(bit)

■ Modbus - RTU

COM.P : MODB, BPS : 9600, PRTY : EVEN, STOP : 1 - BT(bit), DTLN(Fixed) : 8 - BT(bit)

PID CONTROLLER

4) K50 D-REGISTER MAPPING



READ ONLY



READ / WRITE

ADDRESS		PROCESS	CTRL	PGM	SV/PID	HBA/ALM	RET/COM	OUT/IN
Modbus		0	100	200	300	400	500	600
400 001	0				SV.NO	HBA1	RET	OUT
400 002	1	N.PV			SV1	H1DB	RET.H	O.ACT
400 003	2	N.SV	ZONE		SV2		RET.L	CT
400 004	3		FUZY		SV3			CTC
400 005	4		ARW					HYS
400 006	5	M.OUT			AT.M			PO
400 007	6		DIS		AT			POC
400 008	7							OL - H
400 009	8	PID.N	UP.RT					OL - L
400 010	9	ALM.S	DN.RT					
400 011	10		RTMU		1.P	A1TY	COM.P	INP
400 012	11				1.I	A2TY	BPS	UNIT
400 013	12				1.D		PRTY	FR - H
400 014	13				1.MR	A1DB	STOP	FR - L
400 015	14	HCM1			1.Pc	A2DB	DTLN	DP - P
400 016	15				1.Ic		ADDR	SL - H
400 017	16	ADE.S			1.Dc	AL - 1	RSPN	SL - L
400 018	17	ERR.S			1.DB	AL - 2		FILT
400 019	18	MOD.S			1.RP			BIAS
400 020	19							B.OUT
400 021	20				2.P			
400 022	21				2.I			
400 023	22				2.D			
400 024	23				2.MR			
400 025	24				2.Pc			
400 026	25				2.Ic			
400 027	26				2.Dc			
400 028	27				2.DB			
400 029	28				2.RP			
400 030	29							
400 031	30				3.P			
400 032	31				3.I			
400 033	32				3.D			
400 034	33				3.MR			
400 035	34				3.Pc			
400 036	35				3.Ic			
400 037	36				3.Dc			
400 038	37				3.DB			
..	..							
..	..							
400 099	99							

When using the communication options, please refer to the separately provided K50 series communication protocol manual. Only the basics are outlined here.

PHOTO SENSOR

PROXIMITY SENSOR







FLOATLESS LEVEL SWITCH

PID TEMP. CONTROLLER

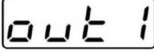
PID CONTROLLER

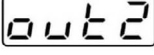
[8] Output group setting

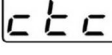
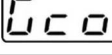
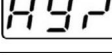
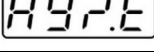
K50 series is used for heating and cooling, and has both multiple inputs and outputs.
User may select among relay, SSR, or SCR(4~20mA DC) for output.

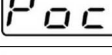
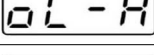
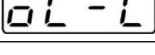
Display	Description	Setting range	Condition	Initial value
	Enter to output setting group			
	Select of output1	0(on/off) / 1(SSR) / 2(SCR) / 3(Relay), (Refer to P8.2)	Always	1 (SSR)
	Output action selection	REV (Reverse action) / DIR (Direct action) Dual (Heating & Cooling)	Always	REV
	Select of output2 (coolingonly)	1(SSR)/2(SCR)/3(Relay)(P9,2,2) refer to the Output configuration	Heating & Cooling Model	1 (SSR)
	Cycle time	1 ~ 1000 sec.	SSR / RELAY control	2 sec.
	Cycle time of cooling output	1 ~ 1000 sec.	Heating & Cooling Model	2 sec.
	Cooling gain setting	0.1~10.0	Heating & Cooling Model	1.0
	Hysteresis (ON/OFF control)	EUS (0.0~100.0 %)	ON/OFF control	2
	Hysteresis action selection when ON/OFF control	HALF / NORMAL	ON/OFF control	NORM
	Output 1 volume when input disconnected (OUT1)	-5.0 ~ 105.0 %	Always	0.0 %
	Output 2 volume when input disconnected (OUT2)	-0.0 ~ 105.0 %	Heating & Cooling Model	0.0 %
	High limit of output	OL-L ~ 105.0 %	PID control	100.0 %
	Low limit of output	-0.5 % ~ OL-H	PID control	0.0 %

When PID control is set to Relay output code 3, the output cycle (Ct) is set to 20 seconds and the voltage pulse (SSR) output code is set to 1, the output cycle (Ct) is automatically set to 2 seconds.
When changing the setting , set is separately.

1) Setting output amount for the event that input has been cut off (Po)

If there is a problem with the input sensors or if for any reason the temperature controller does not function properly, this safety function shuts off internally controlled output or maintains steady output at a desired level.

2) Output limitation in high/low (OL-H, OL-L)

Since the K50 series uses the S-PID algorithm, this function is not necessary in most cases.





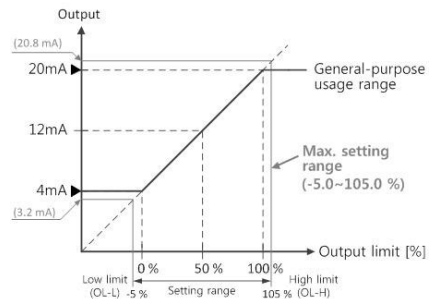





This function may be used when special circumstances require limiting the output.

Using the default value (0~100.0%) is recommended.



[9] Input group setting

The K50 series supports a wide range of specifications, including 12 types of thermocouples (TC), 2 types of platinum resistance thermometers (RTD), and 3 types of current and voltage inputs.

Display	Description	Setting range	Condition	Initial value
	Enter to input setting group			
	Input type selection	1 ~ 33 (refer to P7, 2 - 1.)	Always	1
	Input temperature unit selection	/ °F	TC or RTD input	
	High limit	Within input range (refer to next page) but, Fr-H > Fr-L	Always	1370
	Low limit		Always	-200
	Decimal point positioning (on voltage input)	0 / 1 / 2 / 3 (On voltage input)	On voltage input (mV, V)	1
	Scale high (On voltage input)	-1999 ~ 9999 But , SL-H > SL-L Decimal point positioning by DP-P	On voltage input (mV, V)	100.0
	Scale low (On voltage input)			0.0
	Input digital filter	OFF / 1~120 sec.	Always	OFF
	Input correction	EUS (-100.0~100.0 %)	Always	EUS (0.0 %)
	Burn - out selection	OFF / UP / DOWN	Always	UP



When the input type is changed, all parameters are reverted to their factory default. This means that before using the K50, the input type needs to be set first, after which other parameters can be configured. If the input settings are changed while in use, auto-tuning and other parameters need to be reconfigured.

1) Input type selection

This is the first thing that needs to be checked and set before using the K50, as the settings here will cause other parameters to be reset to their typically optimal values for that specific type. Please refer to the “ Input type selection codes table ” on the next page.

2) Input unit selection (°C / °F)

This selects the unit of temperature measurement to be displayed when using temperature sensors. The Celsius degree is set as the default, but it may be changed to the Fahrenheit degree. On products sold in Korea, the units are fixed to the Celsius degree in compliance with the regulations.

3) Setting decimal point position (DP-P), and free scale high and low limits (SL-H, SL-L)

This applies only when using voltage inputs (DC V, mV) or currents between 4 to 20mA (1~5V). The user may set ranges, units and decimal point position as desired. This can be used not only for temperatures but also for a number of other measurements, including humidity, pressure, and weight.

PID CONTROLLER

4) Digital input filter (FILT)

This function is useful when suboptimal environments cause noises or severe fluctuations, enabling a digital software filter. The filter's sensitivity may be set from off to 1~120 seconds.

Please be careful when using this function, as it may affect the control-related algorithms.

5) Input value bias (BIAS)

This function allows the input values to be compensated. This function is useful, for example, when sensors cannot be placed at desired locations, or when several different thermometers are used in conjunction. The values may be compensated to extent

■ Input type selection codes table

Input type	Signal	Setting Code	Temperature range	Accuracy	Remarks
Thermocouple (T.C)	K	1	-200 ~ 1370	± 0.3% of F.S +1Digit	* F.S is max. value to min. value of each range * Digit is minimum of display 0~400 range : ± 10% of F.S+1Digit
		2	-199.9 ~ 999.9		
	J	15	-200 ~ 1000		
		3	-199.9 ~ 999.9		
	E	16	-200 ~ 1000		
		4	199.9 ~ 999.9		
	T	5	-199.9 ~ 400.0		
	R	6	0 ~ 1700		
	B	7	0 ~ 1800		
	S	8	0 ~ 1700		
	L	17	-200 ~ 900		
		9	-199.9 ~ 900.0		
	N	10	-200 ~ 1300		
	U	11	-199.9 ~ 400.0		
C (W5)	12	0 ~ 2300			
D (W3)	13	0 ~ 2400			
RTD	JPt100 Ω (JIS,KS)	20	-199.9 ~ 500.0		
		22	-200 ~ 500		
	Pt100 Ω (DIN,IEC)	21	-199.9 ~ 640.0		
		23	-200 ~ 640		
Voltage (VDC/mVDC)	0~100 mV DC	33	0 ~ 100mV DC		
	-10~20 mV DC	32	-10 ~ 20 mV DC		
	1~5V DC	30	1~5V DC		
Current	4~20mA DC	30	When using current input, use the resistor 250Ω on input terminal.	When using 1~5V input (30), the interior jumper switch must be relocated.	

