

PART4

PID TEMP. CONTROLLER



K30-SERIES

K50-SERIES

MICRO COMPUTER

Digital PID Controller

User's Manual

K30-SERIES

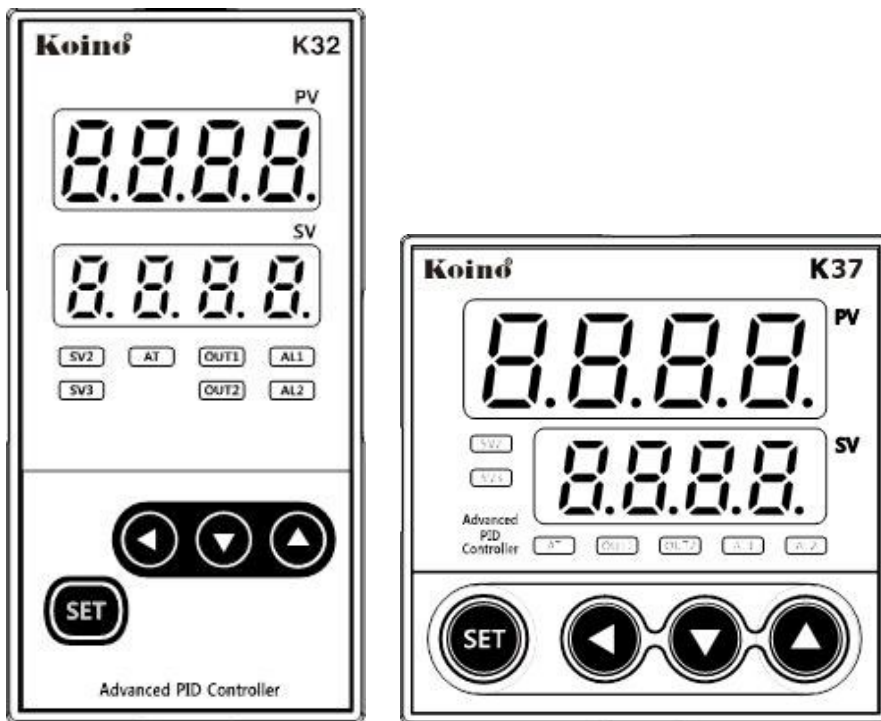

Koino[®]

Preface

Thank you for purchasing the K30 series from Koino.

The K30 series is a precision industrial controller that uses an advanced 2 degree - of - freedom (DOF) algorithm.

The K30 series consists of 5 models, which are K32, K33, K34, K37, and K39.

This manual explains the installation, the functions, the operation, and the handling of the products.

Please read the manual thoroughly before using the products.

If any difficulties arise while using our products, please call our customer service at +82 - 2 - 2242 - 1275.

Pay attention to the followings!

Use the products under the conditions specified in this manual.

Please heed the cautions and warnings listed in this manual.

The contents of the manual may be changed without notice.

The product is designed to be used installed on a control panel.

This manual is copyrighted, and may not be copied in part or in whole without permission.

The manufacturer takes no responsibility for direct or indirect damages caused by careless operation or operation under unpredictable or risky environments

Safety requirements!

Safety requirements are intended to prevent accidents and dangers through the proper use of the products, so please heed them at all times.

The safety requirements are divided into “cautions” and “warnings”, which indicate the following.

WARNING

Serious injury or death may be caused if instructions are not observed.

CAUTION

Failure to observe these instructions may cause damage to the instrument or some injury to the user.

WARNING

1. Use a separate safety device when this product is used to control a device that could harm lives or expensive property in the event of a malfunction or a breakdown. (This may cause fires, deaths, or damage to property)
2. Do not use this controller at place where there are flammable or explosive gas. (It may cause a fire or explosion.)
3. Before turning the power on, please check that wiring is correct to the number of terminal. (It may cause a fire)
4. Turn off the power during wiring and maintenance to avoid an electric shock.
5. Do not touch the terminals when it is power on.
(It may give an electric shock.)
6. This controller must be mounted on the panel to avoid an electric shock.
7. Do not attempt to disassemble, modify and repair.

CAUTION

1. Please conduct an inspection when water has entered the product.
(It may cause short circuits, fires, and malfunction.)
2. This controller should be used indoors.
(It may shorten the controller ' s life or give an electric shock.)
3. Observe the rated voltage and specification.
(It may cause a fire or shorten the controller ' s life.)
4. Be careful that any of foreign materials do not inflow into the controller.
(It may cause a fire or malfunction of the controller.)
5. Do not give direct vibration or shock to the controller.
(It may cause of malfunction of the controller.)
6. Do not use chemical detergent or solvent, but use a dry towel in cleaning the controller.
(It may cause an electric shock or a fire.)
7. Please check the polarity of power before wiring and connecting the sensor.
(It may cause an electric shock or explosion.)

Contents

1. Ordering Information	78
2. Input ranges & Output constitutions	80
3. Dimensions & Panel cutouts	82
4. Terminal Arrangements & wirings	85
5. Ratings & Specifications	87
6. Name & Function	88
7. Check points before using	89
8. Initial installation & Min. operation procedures	90
9. Flow chart (Parameter structure)	91
10. Setting mode	92
11. Alarm(ALARM1, 2) setting	94
12. Details explanation of primary function	96
12-1. Auto tuning(AT) function	96
12-2. Manipulated variable(Mvn) check mode	96
12-3. Alarm(ALARM1, 2) function	97
12-4. Retransmission output	98
12-5. Input function	98
12-6. SV1, 2 set up control by external contact signal	99
12-7. Set value “ LOCK ” function	99

PID CONTROLLER

1. Ordering Information

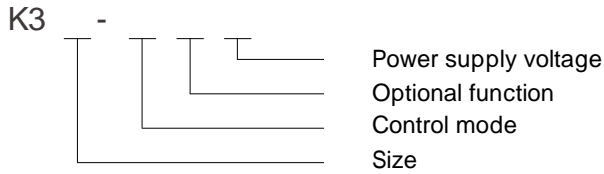

① Size

Code	Model	Size	Remarks
2	K32 - SERIES	48(W) × 96(H) × 77(D)	No option (Basic function)
3	K33 - SERIES	96(W) × 48(H) × 77(D)	No option (Basic function)
4	K34 - SERIES	48(W) × 48(H) × 99(D)	Option : 0, 1, 2, 3
7	K37 - SERIES	72(W) × 72(H) × 77(D)	Option : 0, 3
9	K39 - SERIES	96(W) × 96(H) × 77(D)	No option (Basic function)

Control mode

Code	Description	Remarks
S	SINGLE : Standard	Heating or Cooling control

Power supply voltage

Code	Description	Remarks
0	100 ~ 240 V AC	General - purpose usage
1	24 V AC or DC	Alternating or Direct current usage

PID CONTROLLER

Optional function

Model	Code	Description	Remarks
K32, K33 SERIES	Basic function (0)	RELAY output 1, Alarm output 2,	No function (Basic function S0x)
		SCR(4~20mA), SSR(Voltage pulse) 1,	
		RET(4~20mA Retransmission output)	
		D.I(SV2, 3) External input	
K34 SERIES	Basic function (0)	RELAY output 1 (ALARM or MAIN),	Basic function + Option code (0 : No option)
		SCR(4~20mA), SSR(Voltage pulse) 1	
	1	RET(4~20mA Retransmission), Alarm 2	Ex) K34 - S10
	3	D.I(SV2, 3) External input, Alarm output 2	Ex) K34 - S30
K37 SERIES	Basic function (0)	RELAY output 1, Alarm output 2,	Basic function + Option code (0 : No option)
		SCR(4~20mA), SSR(Voltage pulse) 1	
	3	D.I(SV2, 3), RET(4~20mA Retransmission)	Ex) K37 - S30
K39 SERIES	Basic function (0)	RELAY output 1, Alarm output 2,	Basic function + Option code (0 : No option)
		SCR(4~20mA), SSR(Voltage pulse) 1,	
		RET(4~20mA Retransmission)	

PHOTO SENSOR

PROXIMITY SENSOR

WATER LEVEL CONTROLLER

PID TEMP. CONTROLLER

Example of model building

K34-S00

Size : 48(W) × 48(H) × 99(D) ☞ “ 4 ”
 Control mode : SINGLE ☞ “ S ”
 Optional function : Basic function ☞ “ 0 ”
 Supply voltage : 100~240V AC ☞ “ 0 ”

➔ K34-S00

K37-S30

Size : 72(W) × 72(H) × 77(D) ☞ “ 7 ”
 Control mode : SINGLE ☞ “ S ”
 Optional function : DI(SV1,2), RET ☞ “ 3 ”
 Supply voltage : 100~240V AC ☞ “ 0 ”

➔ K37-S30

2. Input ranges and output constitutions

2-1. Input ranges The K30 series has multiple inputs, which may be set and changed by the user.

Input type	Signal	Setting Code	Temperature range	Accuracy	Remarks
Thermocouple (T.C)	K	1	-200 ~ 1370	± 0.3% of F.S +1Digit	* F.S is max. value to min. value of each range * Digit is minimum of display 0~400 range : ± 10% of F.S+1Digit
		2	-199.9 ~ 999.9		
	J	15	-200 ~ 1000		
		3	-199.9 ~ 999.9		
	E	16	-200 ~ 1000		
		4	199.9 ~ 999.9		
	T	5	-199.9 ~ 400.0		
	R	6	0 ~ 1700		
	B	7	0 ~ 1800		
	S	8	0 ~ 1700		
	L	17	-200 ~ 900		
		9	-199.9 ~ 900.0		
	N	10	-200 ~ 1300		
U	11	-199.9 ~ 400.0			
RTD	JPt100 Ω (JIS,KS)	20	-199.9 ~ 500.0		
		22	-200 ~ 500		
	Pt100 Ω (DIN,IEC)	21	-199.9 ~ 640.0		
		23	-200 ~ 640		
Voltage (VDC/mVDC)	0~100 mV DC	33	0 ~ 100mV DC		
	-10~20 mV DC	32	-10 ~ 20 mV DC		
	1~5V DC	30	1~5V DC		
Current	4~20mA DC	30	When using current input, use the resistor 250Ω on input terminal.	<p>When using 1~5V input (30), the interior jumper switch must be relocated.</p>	

How to change the interior switch when using 1~5V input

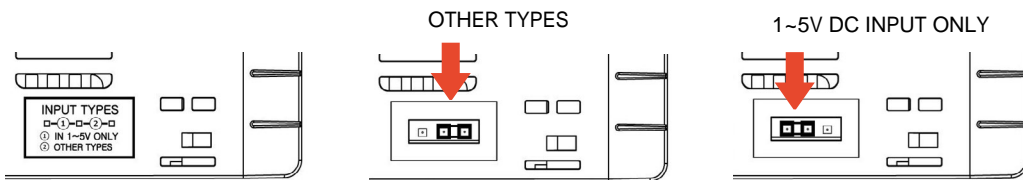

Remove the jumper cover on the underside of the K30, or remove the rear case.

Detach the jumper using tweezers and move it to the 1-2 pins to the left.

Once this has been completed, put the jumper cover back on, as shown on the picture above.

2-2. Output constitutions

The K30 series has multiple outputs.

The figure on the left uses the terminal socket of K37 - S30 as an example to illustrate the output response relationship.

General type	Setting number	OUTPUT-1			OUTPUT-2 (ALARM1,2)		
		Relay output	SSR output	SCR output	AL1	AL2	SCR output
K30 - Sxx	0	OUT(ON/OFF)	ALM1(34 - S0x)	-	ALARM1	ALARM2	RET
	1	ALM1(34 - S0x)	OUT(PID)	-			
	2	ALM1(34 - S0x)	-	OUT(PID)			
	3	OUT(PID)	ALM1(34 - S0x)	-			

Summary and explanation of output settings

Relay output of ON/OFF control [Output setting number : 0]

This is a simple on/off control, mainly used to control cooling devices.

SSR output of PID control (Voltage pulse) [Output setting number : 1]

This is the most widely used setting, and the default value at the point of manufacture.

SCR output of PID control (4~20mA current output) [Output setting number : 2]

This setting is used mainly with thyristor power regulator (TPR) modules, and is capable of precision control.

Relay output of PID control [Output setting number : 3]

This is the most cost-efficient method of implementing PID control and is used mainly with magnetic switches (electric switches). However, it may wear the contact point, and is difficult to use in places that require fast response.

Alarm output of K34(48' 48) basic type(S00)

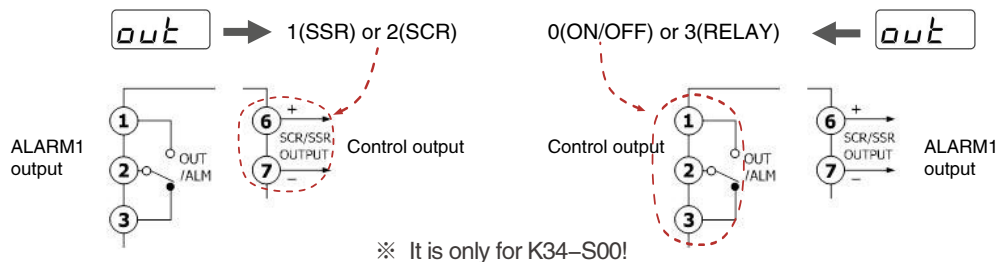

With the basic model of K34 (48x48), caution is required when using its alarm output. When control output is being used as a relay, the alarm output will be SSR output (voltage pulse). In this case, use SSR or alarm option (S10, S30) enabled models.

PID CONTROLLER

3. Dimensions and panel cutouts

1) K32 (48 × 96 mm) Dimensions

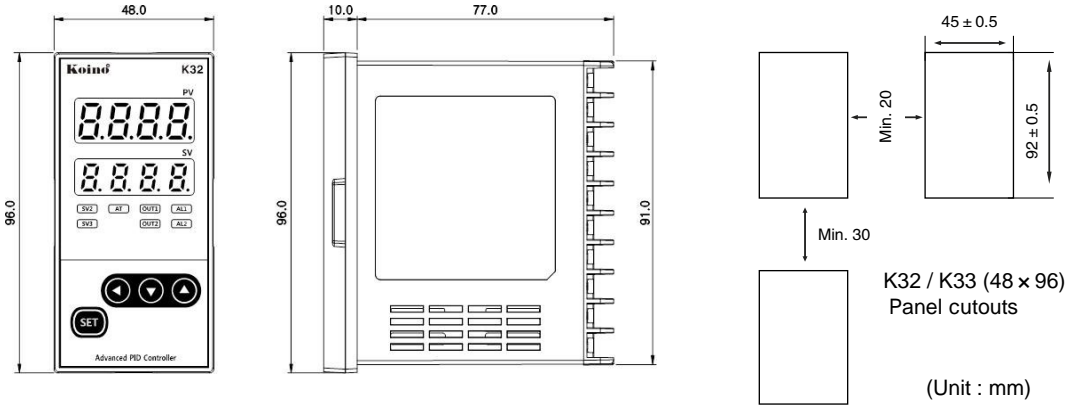

2) K33 (96 × 48 mm) Dimensions

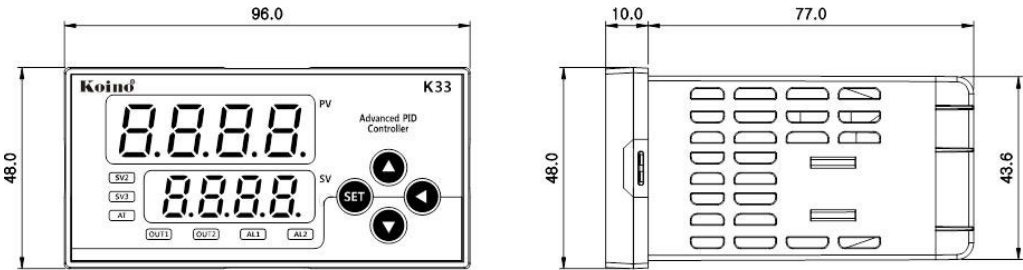

3) K34 (48 × 48 mm) Dimensions

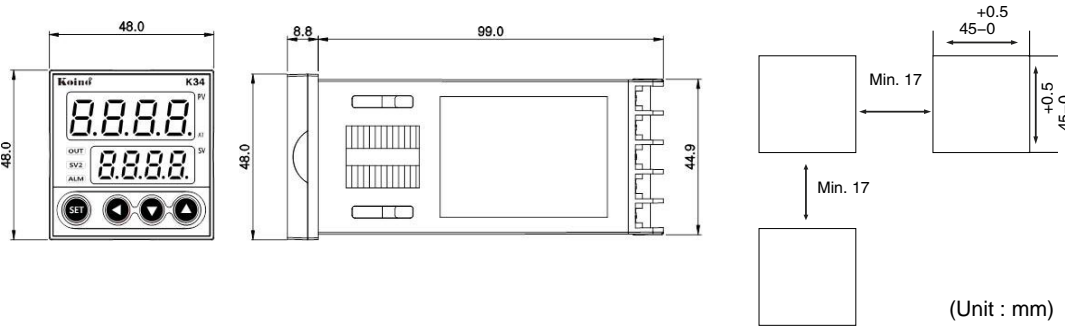

PID CONTROLLER

4) K37 (72 × 72 mm) Dimensions

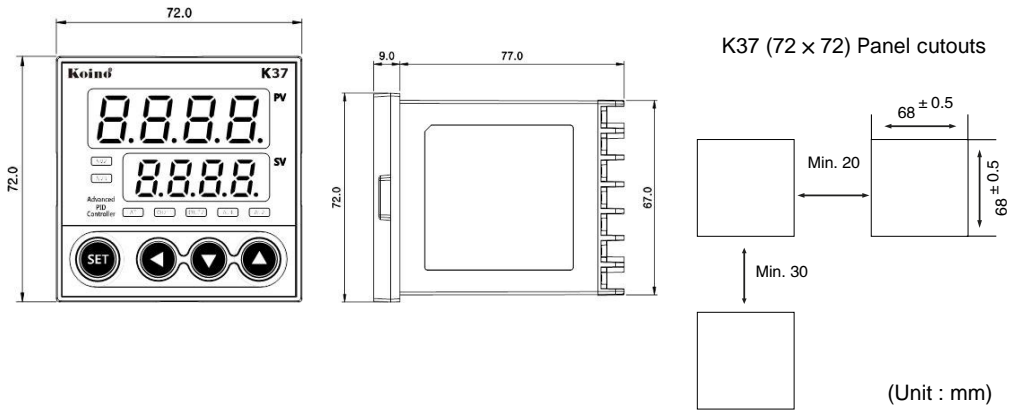

5) K39 (96 × 96 mm) Dimensions

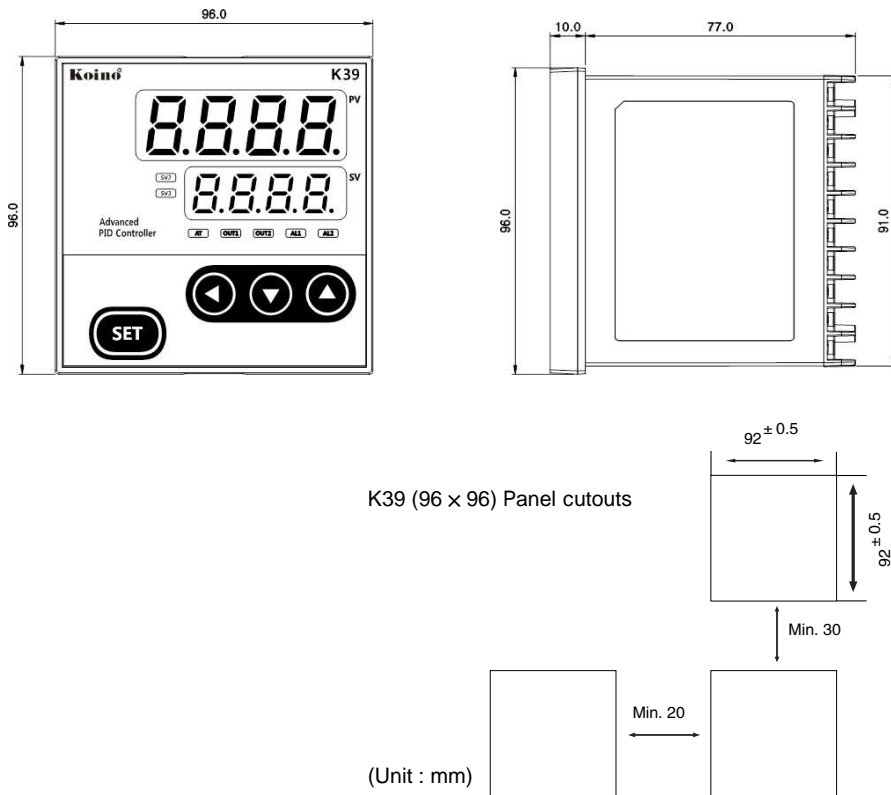

PHOTO SENSOR

PROXIMITY SENSOR

WATER LEVEL CONTROLLER

PID TEMP. CONTROLLER

Installation

■ K34-SERIES

Bore a hole in the panel, referring to the panel cutouts on the previous page.
Insert this device into the front of the panel.
From the rear of controller, slide the bracket over the housing.
Push the bracket in until the device has been fixed securely onto the panel.
Secure using screws on the two locations at top and bottom as shown on Figure 2.

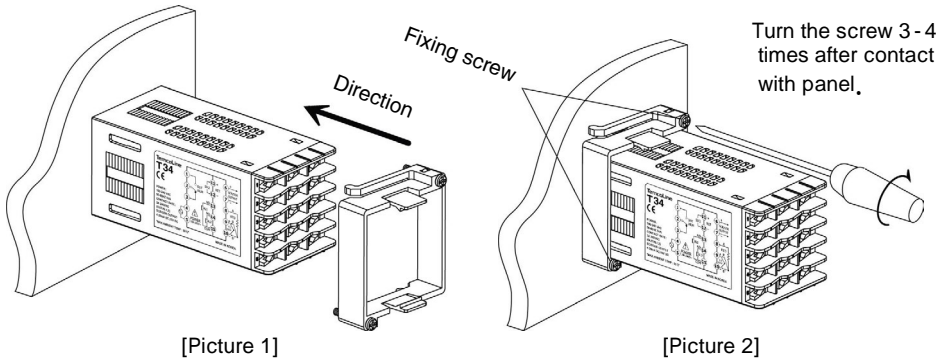

■ K32 / K33 / K37 / K39-SERIES

Bore a hole in the panel, referring to the panel cutouts on the previous page.
Insert this device into the front of the panel.
Insert 2 brackets, one each on the B/K holes on the top and the bottom of the device.
Secure using screws on the two locations at top and bottom.

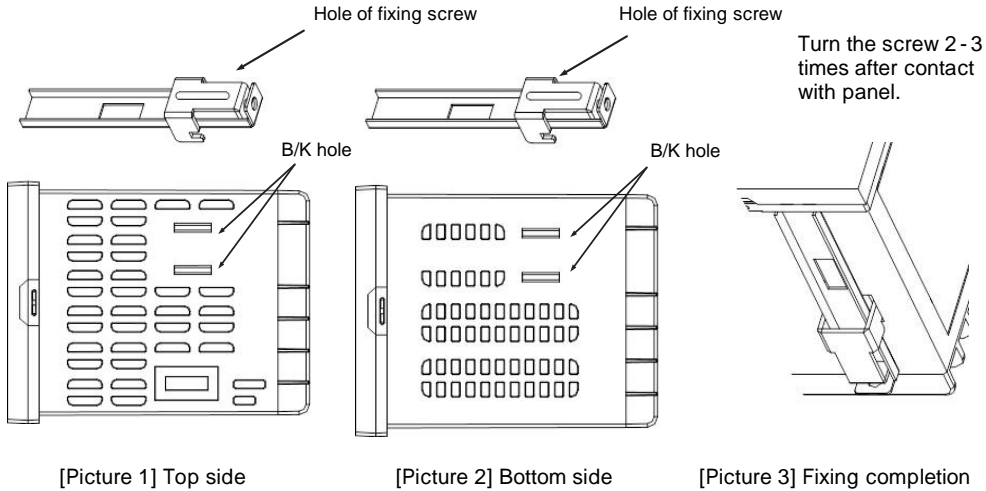

4. Terminal arrangements and wirings

1) K32 (48 × 96 mm), K33 (96 × 48 mm)

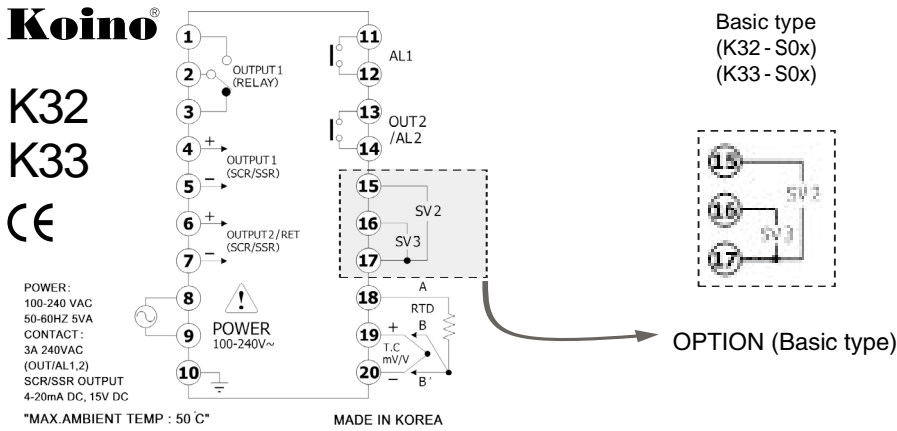

2) K34 (48 × 48mm)

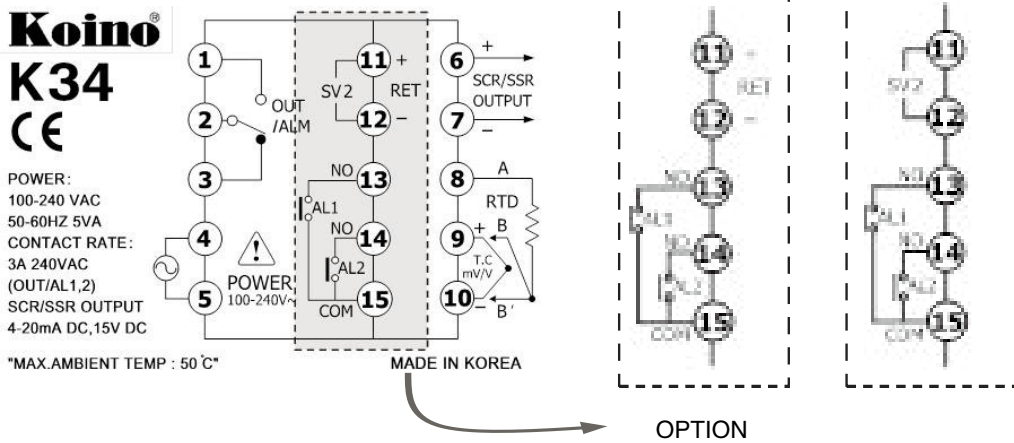

PID CONTROLLER

3) K37 (72 x 72 mm)

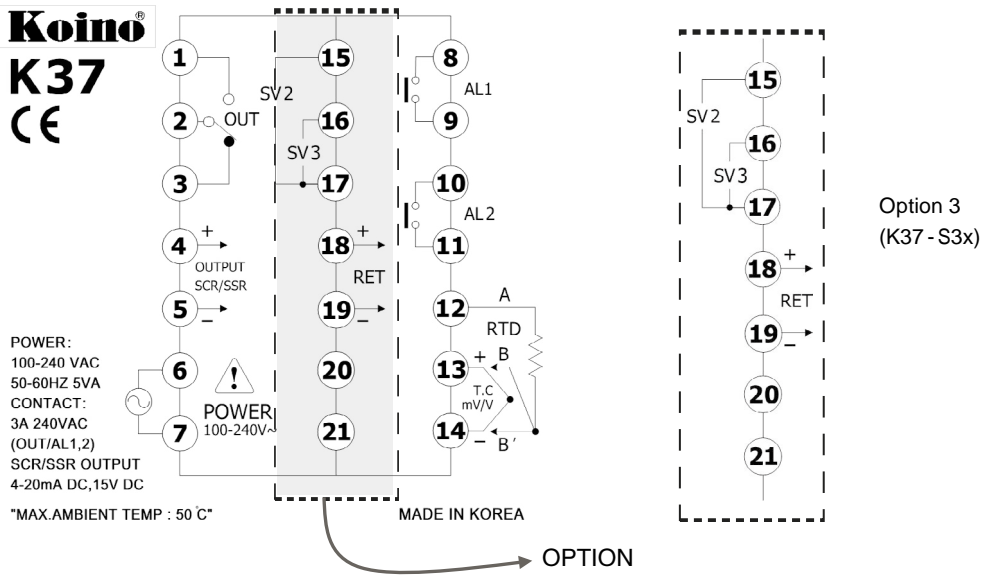

4) K39 (96 x 96 mm)

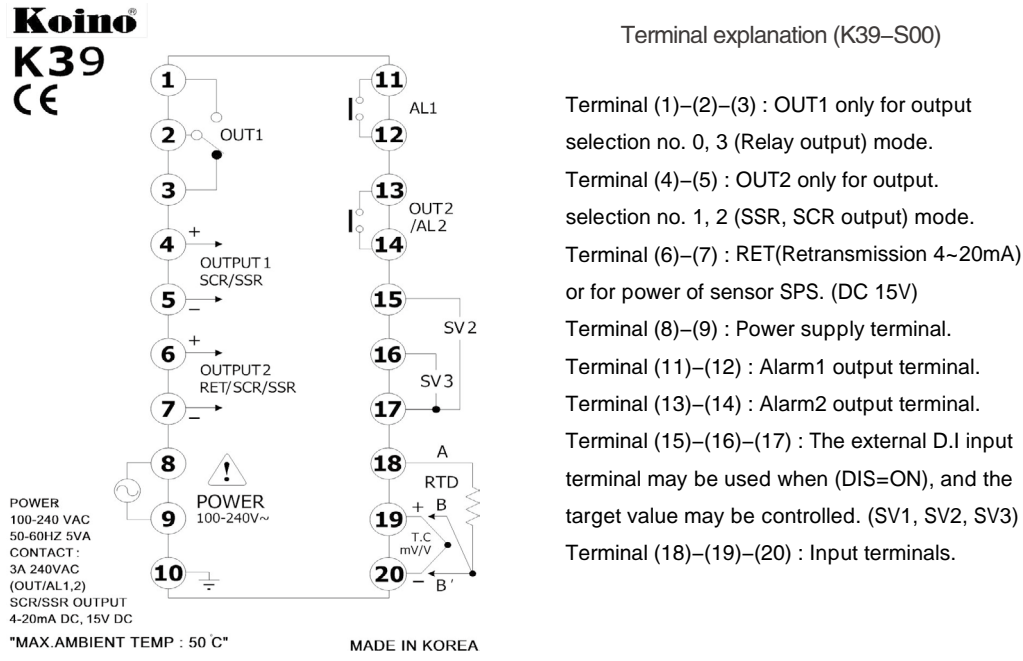

5. Ratings and specifications

Model	K30-SERIES	
Power supply	100~240V AC 50~60Hz (Operating voltage range 85~265V AC) 24V AC or DC (Operating voltage range 20~28V DC)	
Power consumption	6VA (Max.)	
Sensor input	Thermocouple (TC) : K, J, T, E, R, B, S, L, N, U, C(W5), D(W3) Resistance temp. detector (RTD) : KPt100(KS), JPt100(JIS), Pt100(DIN) Current input : 4~20mA DC Voltage input : 1~5V DC, -10~20mV DC, 0~100mV DC	
Accuracy	± 0.3% of FS +1Digit	
Input impedance	Current input (250 Ω), Voltage input (including TC) 1M Ω min. (RTD allowable wiring resistance : 10 Ω max., but, 3 wires have a equal resistance)	
Input sampling period	250ms (changeable according to SG - PID algorithm)	
Control output	Relay	1c 250VAC, 3A(resistive load) Electrical life 100,000 min. (PID output or ON/OFF output)
	Voltage (S.S.R)	DC15V 25mA (Built-in short protection circuit) Voltage pulse (PID output)
	Current (S.C.R)	4~20mA DC, allowable load impedance 600 Ω max. (PID output)
Control type	Super 2 degree - of - freedom PID (SG - PID algorithm), S - Fuzzy, Auto - Tuning	
Digital Input	ON : 1K Ω max., OFF : 100K Ω min. (SV1, 2, 3 external control input)	
Retransmission output	4~20mA DC, allowable load impedance 600 Ω or less. Resolution 1/4600 PV, SV, MV[%], SPS	
Alarm	ALARM1, 2	1a 250V AC 3A (Resistive load)
	HBA(C.T) com.	HBA : 1~50A AC (Resolution 0.5A)
Ambient temperature and humidity	-10~50 °C / 25~85% RH (with no condensation or icing)	
Weight (incl. B/K & accessories)	K32, K33, K37 - SERIES : 230g K34 : 140g K39 : 320g When option + 30g	

6. Name & Function (ex. K34-SERIES)

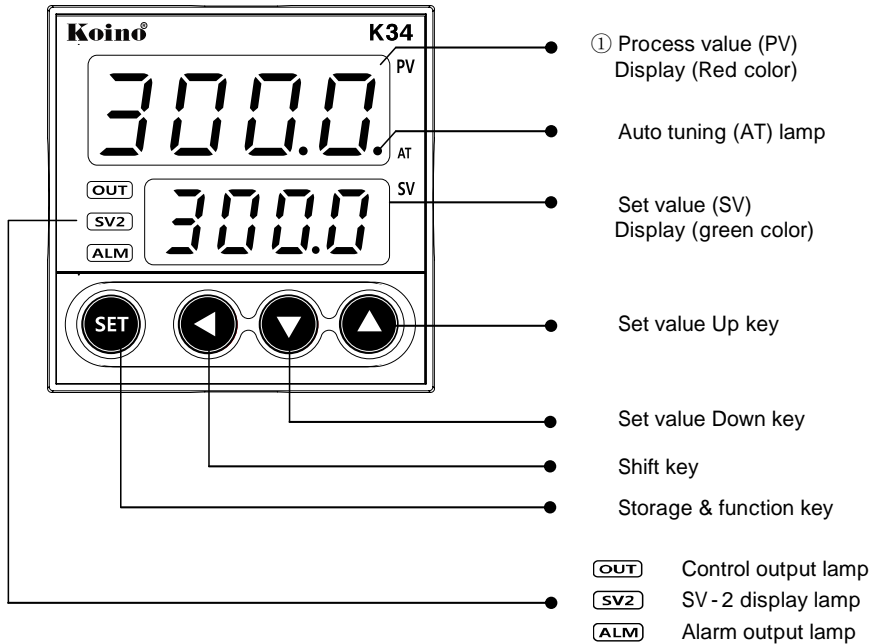

◆ Description

Name	Function
Process value	Display the process value. (red color)
Auto tuning lamp	Flash every 0.5 second during auto tuning.
Set value display	Display the set value, codes, and modes.
Control output lamp	Lights when the control output is ON.
SV - 2 display lamp	Lights when the SV 2 is displayed.
Alarm output lamp	Lights during the alarm is ON.
Function key	Use to move the menus, to store, and to operate.
Shift key	Use to shift the digits.
Set value down key	Use to decrease set value and to move the menu.
Set value up key	Use to increase set value and to move the menu.

7. Check Points before Using

1) Default values at the point of manufacture

The default input and output values of the product at the point of manufacture are as follows.

Input : K-Type (Sel. code 1) Output : SSR mode (Sel. code 1)

In the case of the basic model of K34-S00 only, when SSR(1) or SCR(2) is chosen as the output mode, Alarm 1 output will be in main relay. (Refer to page 8 for details)

2) 7 Segment display indications

A	b	c	d	E	F	G	H	I	J	K	L	ñ
A	B	C	D	E	F	G	H	I	J	K	L	M
n	o	P	q	r	s	t	u	v	w	x	y	z
N	O	P	Q	R	S	T	U	V	W	X	Y	Z

3) Initial display on power supply (K34-SERIES basis)

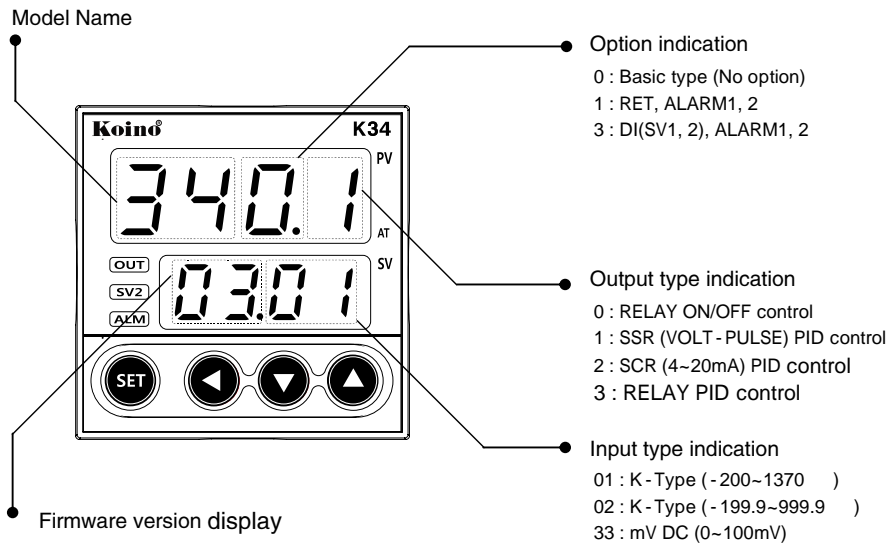

8. Initial installation and minimum operation procedures

The following are the instructions for initial installation and minimum operation procedures.

Please read the contents of this manual, including the general functions outlined here, as thoroughly as possible before operating the device.

1) Check the external wiring diagram and specifications
(power supply and terminal arrangement)

2) Check input and output specifications!

The default setting for the K30 series at the point of manufacturer are as follows.

Input : K(CA) Type (setting code 1)

Output : SSR mode (setting code 1)

If you wish to change the input or the output type, please select the option you desire on the input group and the output group menus.

The input type settings must be configured first before changes to other set values are made.

When the input type is changed, all other parameters (set values) are reverted to their factory default.

3) Select the desired set value (SV).

4) Please set auto - tuning or P, I, D values to suit the operating environment.

Auto - tuning is recommended except under special circumstances

Set value(SV) setting [in condition of Mvn = OFF (basic)]



Enter to setting mode by **SET** key

Set a desired value by **← ↓ ↑** key

Store a value by **SET** key

Auto tuning

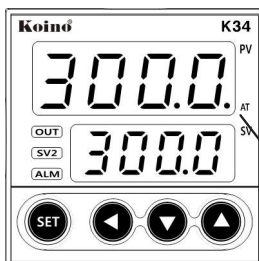

AT operation start : **SET** + **↑** 0.5 second

AT stop by perforce : **SET** + **↑** 0.5 second

● AT command lamp (flash every 0.5sec.)

Tuning is required before operating for the first time. Set the target value(SV) in the range mainly used and run auto - tuning. When auto - tuning begins, the “ auto - tuning command lamp ” will flash every 0.5 second and will turn off upon completion of the tuning process. Please refrain from operating the keys while auto - tuning is in progress.

9. Flow Chart (Parameter structure)

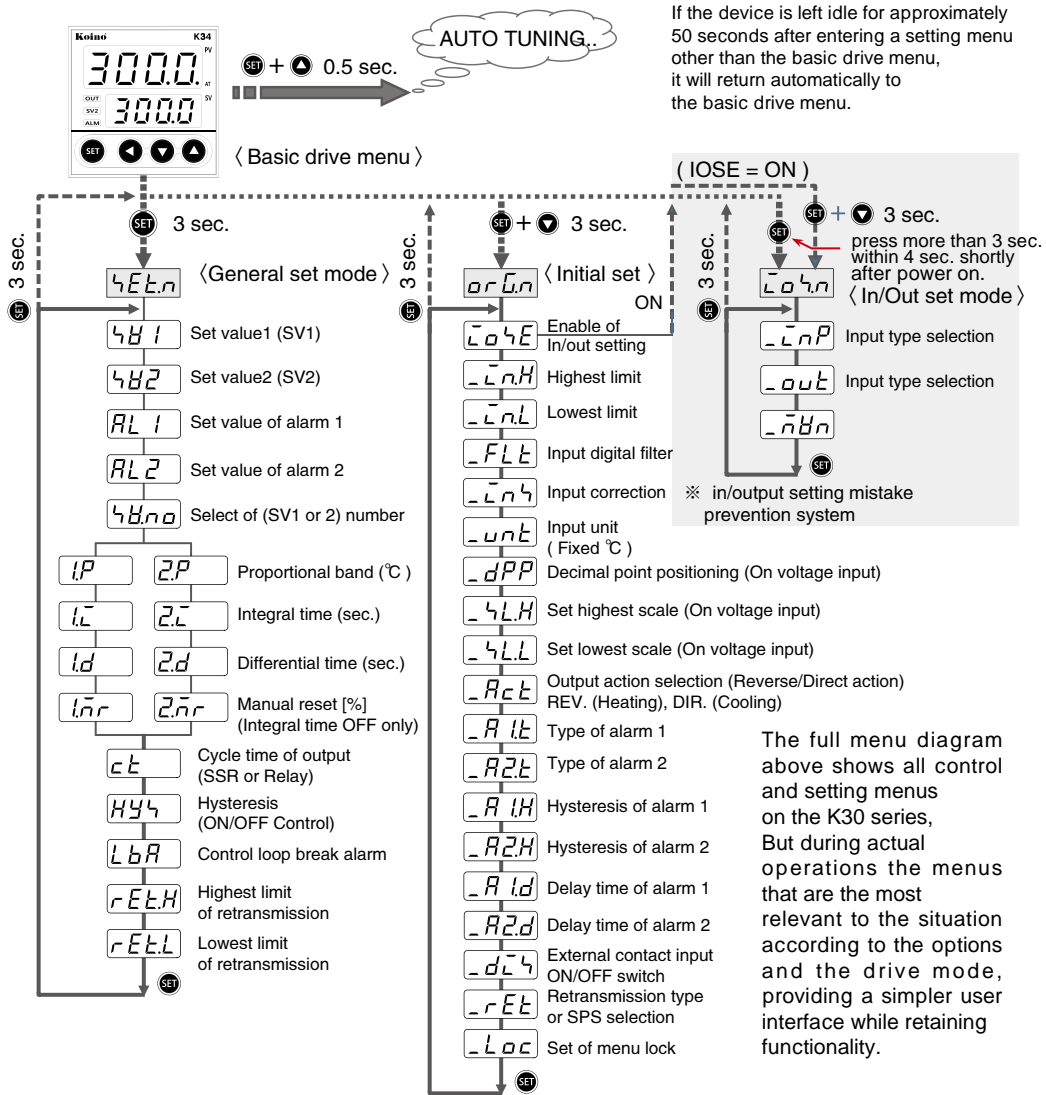

If the device is left idle for approximately 50 seconds after entering a setting menu other than the basic drive menu, it will return automatically to the basic drive menu.

The full menu diagram above shows all control and setting menus on the K30 series, But during actual operations the menus that are the most relevant to the situation according to the options and the drive mode, providing a simpler user interface while retaining functionality.

< Process of "in/output set mode" >

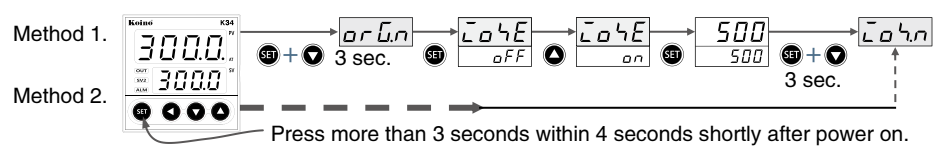

※ To enter "Input/Output settings" by "IOSE" On is valid for only one time. If you want to enter "Input/Output settings" again you must turn on "IOSE" first. If there is no Key action the "IOSE" will be OFF automatically in 40 seconds.

PHOTO SENSOR

PROXIMITY SENSOR

WATER LEVEL CONTROLLER

PID TEMP. CONTROLLER

10. Setting mode

1) General setting mode

The general setting mode is for changing environment parameters on ad hoc basis and also for tuning performance enhancement and configuring other functionalities.

Display	Description	Setting range	Condition	Initial value
4E.t.n	Display general setting mode			
481	Set value 1 (SV1) setting	EU (0 ~ 100 %)	D.I Option in use	EU (0 %)
482	Set value 2 (SV2) setting	EU (0 ~ 100 %)	D.I Option in use	EU (0 %)
AL1	Set value of alarm 1 (AL1)	EU (0 ~ 100 %)	Use Alarm 1	EU (100 %)
AL2	Set value of alarm 2 (AL2)	EU (0 ~ 100 %)	Use Alarm 2	EU (0 %)
48.no	Selection of (SV1, 2) number	1 / 2	Always	1
n.P	SV1, 2 proportional band (P)	0 ~ 999.9	PID control	20.0
n.L	SV1,2 Integral time (I)	OFF / 1 ~ 6000 sec.	PID control	240 sec.
n.D	SV1,2 Differential time (D)	OFF / 1 ~ 6000 sec.	PID control	60 sec.
n.MR	SV1,2 Manual reset (MR)	-5.0 ~ 105.0 %	Integral time OFF	50.0 %
ct	Cycle Time (P.I.D Control Only)	1 ~ 1000 sec.	PID control (SSR or RELAY)	2 sec.
H44	Hysteresis (ON/OFF control)	EUS (0 ~ 100 %)	ON/OFF control	EUS (0.5 %)
LbA	Control loop break alarm (LBA)	OFF / 1 ~ 9999 sec.	ALARM1 No. 21 selection	480 sec.
rEt.H	Highest limit of retransmission (RET.H)	TC/RTD : _IN.H~_IN.L DCV IN : _SL.H~_SL.L (But, RET.H > RET.L)	Use retransmission and select PV or SV	EU (100 %)
rEt.L	lowest limit of retransmission (RET.L)			EU (0 %)

※ EU : An engineering unit in compliance with the input range

ex) Input selection no. : 01 (K-TYPE)

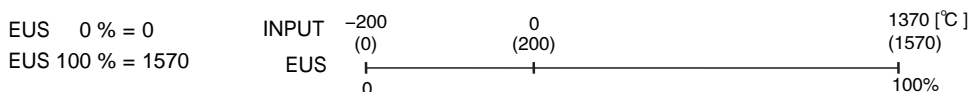

PID CONTROLLER

2) Initial setting mode

The initial setting mode is for setting up initial parameters and configuration for overall control and functionalities activation that are rarely changed after the initial setup.

Display	Description	Setting range	Condition	Initial value
orGn	Initial set mode (ORG.N)			
IOSE	I/O setting entry switch (IOSE)	ON / OFF	Always	OFF
_IN.H	Set highest input range (_IN.H)	Within input range (See input type and range) But, _IN.H > _IN.L	Always	1370
_IN.L	Set lowest input range (_IN.L)			-200
_FLT	Set input digital filter value (_FLT)	OFF / 1~120 sec.	Always	OFF
_INS	Input value correction (_INS)	OFF / 1~120 sec.	Always	OFF
_UNT	Input temperature unit selection (Fixed Celsius)	/ °F	TC or RTD input	
_DPP	Select the decimal point position in Voltage input mode (_DPP)	0 ~ 3	Voltage or 4~20mA input mode only	1
_YLH	Free scale upper limit set (voltage input mode)	-1999 ~ 9999 But, SL-H > SL-L Decimal point positioning by _DPP		100.0
_YLL	Free scale lower limit set (voltage input mode)			0.0
_Act	Output action selection	REV (Heating), DIR (Cooling)	Always	REV (Heating)
_A1t	Select alarm 1 output type	OFF / 1 ~ 21(LBA) (See alarm type)	Always	1
_A2t	Select alarm 1 output type	OFF / 1 ~ 20 (See alarm type)	Using alarm 1, 2 option	2
_A1H	Hysteresis of alarm 1 output	EUS (0.0 ~ 100.0 %)	Using alarm1 (1~20)	EUS (0.5%)
_A2H	Hysteresis of alarm 2 output	EUS (0.0 ~ 100.0 %)	Using alarm2	EUS (0.5%)
_A1d	Delay time of alarm 1	OFF / 1 ~ 240 sec.	Using alarm1	OFF
_A2d	Delay time of alarm 2	OFF / 1 ~ 240 sec.	Using alarm2	OFF
_dCY	External contact input (SV1, 2) ON/OFF switch	OFF / ON	Using RET option	OFF
_rEt	Retransmission type or SPS selection	PV / SV / MV / SPS	Using RET option	PV
_Loc	Set data protection	OFF / ON / ALL	Always	OFF

PID CONTROLLER

2) In/Output setting mode

The input/output setting mode is a parameter for the first time use. It 's a hardware configuration so requires special user caution. That is, the configuration is determined by the type of equipment and it must be configured first. (all parameters are initialized according to the entered input type)

Display	Description	Setting range	Condition	Initial value
	In/output setting mode			
	Input type selection (_InP)	1 ~ 33 (refer to P7, 2-1.)	Always	1
	Output type selection (_out)	0 ~ 3 (refer to P8, 2-2.)	Always	1
	Manipulated variable (_Mvn) Display setting	OFF / ON	Always	OFF



When the input type is changed, all parameters are reverted to their factory default. This means that before using the K30, the input type needs to be set first, after which other parameters can be configured. If the input settings are changed while in use, auto-tuning and other parameters need to be reconfigured.

11. Alarm(ALARM1,2) Setting

The K30 series has two separate alarm outputs, and in the setting group, alarms may be chosen among 21 types, and the dead band (hysteresis) for the alarm output may be set.

Please find the alarm code with the desired function in the “ Alarm types and codes table ” on the next page and use it to set the alarm output type in the settings mode.

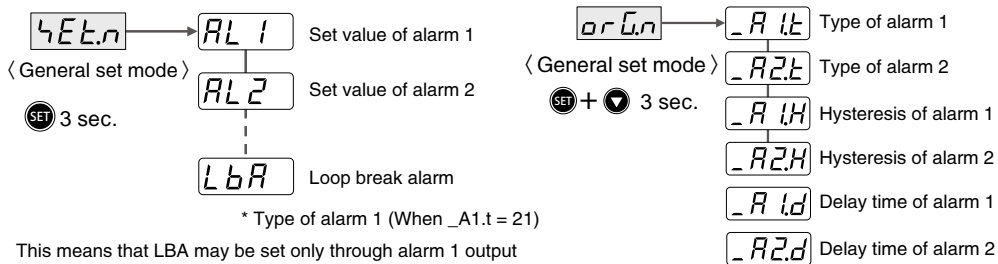

1) Hold function

When a low alarm is set and during temperature is rising, an unnecessary low alarm may be happen. The hold function may be used to eliminate such problems.

The hold function allows the low alarm to be ignored automatically until the temperature rises above the alarm threshold level for the first time when electricity is first turned on.

Hold function: None

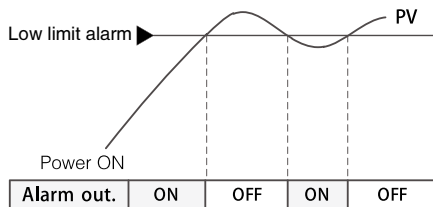

Hold function

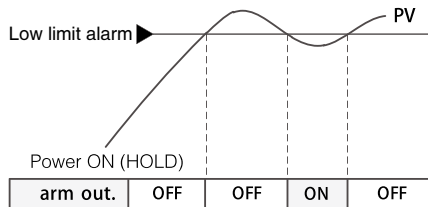

PID CONTROLLER

2) Alarm output type and Selection code

Code no.	Alarm type	Alarm output operation
01	Absolute value upper-limit	
09	(Inverted output)	
11	with Hold function	
19	with hold function (Inverted)	
02	Absolute value lower-limit	
10	(Inverted output)	
12	with Hold function	
20	with hold function (Inverted)	
03	Upper-limit deviation	<p><Negative temp. value setting> <Positive temp. value setting></p>
05	(Inverted output)	
13	with hold function	
15	with hold function (Inverted)	<p><Negative temp. value setting> <Positive temp. value setting></p>
04	Lower-limit deviation	
06	(Inverted output)	
14	with hold function	
16	with hold function (Inverted)	
07	Upper & Lower - limit deviation	
17	Upper & Lower - limit deviation with hold	
08	Upper & Lower - limit deviation in range	
18	Upper & Lower - limit deviation in range with hold	<p>Refer to HBA ! (ALARM1 only)</p>
21	Loop break alarm (LBA)	

When alarm type reverse - correspondence is selected for alarm type and code, please be aware that when the alarm lamp turns on, the contact output will be off.

Example of Alarm output 1 setting

- A 1 6 4** Alarm type (Upper - limit deviation) = 03
- A 1 0 b** Hysteresis (Dead band) = 2
- AL 1** Alarm setting value = 20

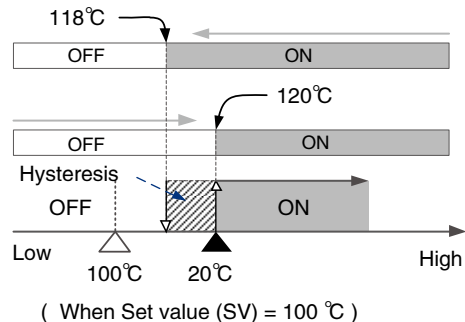

12. Details explanation of primary function

12-1. Auto tuning (AT) function

Before the PID temperature controller can be used for the first time, the P, I, D values must be tuned. The auto-tuning function finds the optimal value by tuning automatically according to the load factor and other conditions.

Please make sure that the controller is tuned before using it for the first time, by defining the set values in the most frequently used range and running auto-tuning. When auto-tuning begins, the “ auto-tuning command lamp ” will flash every 0.5 second and will turn off upon completion of the tuning process. Please refrain from operating the keys while auto-tuning is in progress.



AT operation start : **SET** + **▲** 0.5 second

AT stop by performe: **SET** + **▲** 0.5 second

AT command lamp (flash every 0.5sec.)

Do not use auto tuning under below Process.

- Rapid control Process such as Flow, input control.
- Process which should not ON/OFF output even a temporary.
- Process which should not over load at control.

12-2. Manipulated Variable [%] (Mvn) check mode

< Setting method >



“ Mvn [%] check function ” displays the control output [%], which can be viewed by pressing the “ **SET** ” key while operating in default drive mode and is shown as a percentage of the control output (0~100[%]) in the SV display.

In this mode, pressing the “ **SET** ” key alternates between showing the SV and the Mvn values, and changes to the SV value can be made by “ **▼** ” or “ **▲** ”.

If required, set in the order of **◀** → **SET** .

Refer to P18, I/O set mode

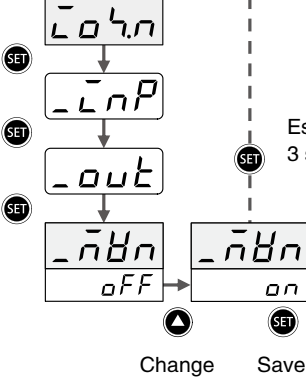

Escape.. 3 sec.

< In condition of Mvn=ON >



Basic drive menu

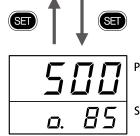

Mvn display screen
(Present Mvn Out = 85%)

12-3. Alarm (ALARM1,2) function

The K30 series has two separate alarm outputs, and in the setting menu, alarms may be chosen among 21 types, and the hysteresis, delay time for the alarm output may be set.

Please find the alarm code with the desired function in the “ Alarm types and codes table ” on the page 21~22 and use it to set the alarm

【 1 】 Delay time of alarm

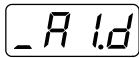

Alarm 1 delay time setting

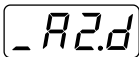

Alarm 2 delay time setting

If you set the alarm delay time, alarm (1 or 2) output waits for the delay time after receiving the alarm. However, it is not applicable when the alarm is turns off.

During the delay time the alarm (ALM) output lamp blink 0.5 second intervals to displays the current alarm is waiting to alert.

【 2 】 LBA (Control Loop Break Alarm)

LBA is functionality where it triggers an alarm when there is no change in input while the difference is in consistent state (it assumes there is certain problem in the control loop). Therefore if the control loop is not in a normal working mode, it can be utilized for detection. E.g. output is generated if there are problems with control unit and other problems or can be used for heater disconnection.

How to set up

Please set value of LBA two times of the normal integral time setting.

In addition, LBA can be set to automatically by the auto turning function.

In this case value will be set up automatically two times of integral times.

Description of operation

Control loop break alarm consists to alert you Control loop break by detect Variation during setting time when P.I.D calculations (On time/period of output) is 0% or 100%.

When P.I.D calculations stays 100% more than LBA setting time, Break alarm will be turned on if calculations is not increase more than 2

(In positive action will turned on if calculations does not fall more than 2)

When P.I.D calculations stays 0% more than LBA setting time, Break alarm will be turned on if calculations is not fall more than 2

(In positive action it will turned on if calculations does not increasemore than 2)

Cause of activation

LBA will activate below condition.

- 1) Abnormalities of the control target : Heater break, No supply voltage,Wrong wiring .etc

PID CONTROLLER

- 2) Abnormalities of the sensor : Disconnection / short circuit of sensor
- 3) Abnormalities of the handling tools : Splice relay, wrong wiring. etc
- 4) Abnormalities of Output circuit : Spliced relay inside of unit, break ON/OFF
- 5) Abnormalities of input circuit : No calculations change even input is change.

Notice

- 1) LBA will work when PID calculations is 0% or 100%. Thus the time from occurring of abnormalities to alarm time will be the time of PID value 0% or 100% plus
- 2) LBA set-up times LBA will not working during auto tuning.
- 3) The LBA function is influenced by disturbances (heat sources, etc) and as a result may be activated even if there is no trouble in the controlled system.
- 4) When LBA setting time is too short or wrong control target, sometimes LBA will be on/off abnormally of not turned on. In this case please set LBA time little longer.

12-4. Retransmission output

In the retransmission output mode, process value (PV), set value (SV), output amount (MV), or sensor power supply (SPS) may be chosen, and the output will be generated in direct current of 4~20mA. (SPS is DC15V/25mA)

_rEt Retransmission type or SPS selection

PV (Current Progress Value)
 SV (Set Value)
 MV (Manipulated Variable)
 SPS (Power supply for external sensor)

rEt.H rEt.L
 Scale setting can only possible when
 retransfer output set - up PV or SV.

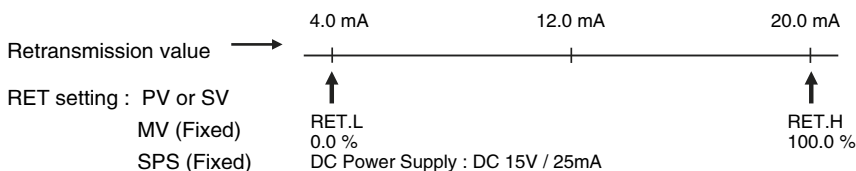

12-5. Input function

1) Digital input filter (_FLT)

This function is useful when suboptimal environments cause noises or severe fluctuations, enabling a digital software filter. The filter 's sensitivity may be set from off to 1~120 seconds.

Please be careful when using this function, as it may affect the control - related algorithms.

2) Input value correction (_INS)

This function allows the input values to be compensated. This function is useful, for example, when sensors cannot be placed at desired locations, or when several different thermometers are used in conjunction. The values may be compensated to extent desired by the user.

3) Setting decimal point position (_DPP), and free scale high and low limits (SL-H, SL-L)

This applies only when using voltage inputs (DC V, mV) or currents between 4 to 20mA (1~5V).

The user may set ranges, units and decimal point position as desired.

This can be used not only for temperatures but also for a number of other measurements, including humidity, pressure, and weight.

12-6. SV1, 2 set up control by External contact signal

_diS	Use SV1,2 by external contact (_diS=ON)	
	SV Action	External terminal status
ON	SV1 Select	OPEN
	SV2 Select	SHORT
OFF	Block external contact signal (Can select under inside menu only)	

Digital input switch (_DIS) :

This function selects whether to use digital input switch. This function the ability to change SV1, 2 to Each pre-set value by an external contact signal.

Please use a non-voltage contact (relays, switches) for direct input. If a non-contact device such as a semiconductor are used, please operate within the ranges ON = under 1K , OFF = over 100K .

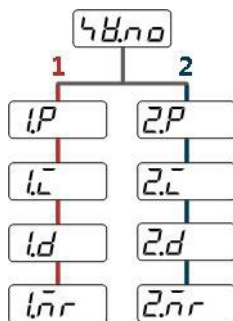

← “SV1,2” selection menu when the (_diS = OFF).

K30 controls when the external or internal SV1 or SV2 select control by independent P, I, D, MR value. As a result, it will have best control performance depending on the temperature value. Typically, when use Auto-tuning, it will work if either SV1 or SV2 tuned and set same P, I, D value with the other.

12-7. Set value “LOCK” function

Lock function will protect change set value and activate function such as auto-tuning from accidental key operation. Please use after setting prevents.

_Loc Lock has 3 setting mode (OFF / ON / ALL)

OFF : LOCK function off

ON : Can operate SV setting and AT only.

ALL : Impossible all setting and operation, only LOCK OF is available.