

H series

H 시리즈 / H系列

• Feature / 특성 / 特征

- 1. SUS hinge, SUS latch and insert
- 1. 스테인레스 힌지, 스테인레스 래치 인서트 있는 제품
- 1. SUS铰链, 采用SUS锁扣 螺母的产品

• Specification / 사양 / 产品规格说明

Temperature range / 온도영역 / 温度范围

ABS : - 40 ~ + 70, PC : - 40 ~ + 110

Flammability Rating / 난연성 / 难燃性

ABS : 94-HB, PC : 94-V-0, 5VA, 94-HB



Medium and large size / 중·대형사이즈 / 中·大型



Medium size / 중형사이즈 / 中型

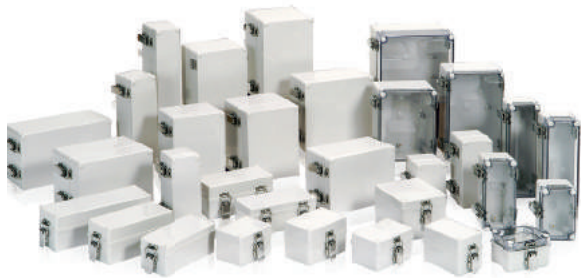

Small size / 소형사이즈 / 小型



Examples of use / 고객사용예 / 使用实例

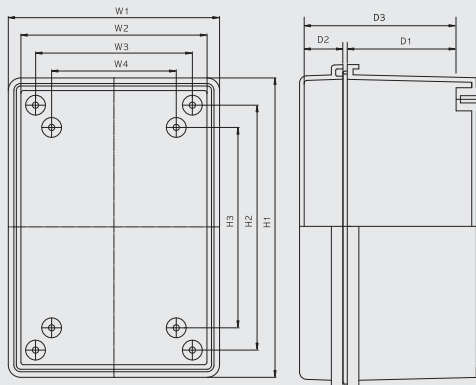

• H Series model name / H시리즈 모델선정방법 / H系列 产品型号命名方法

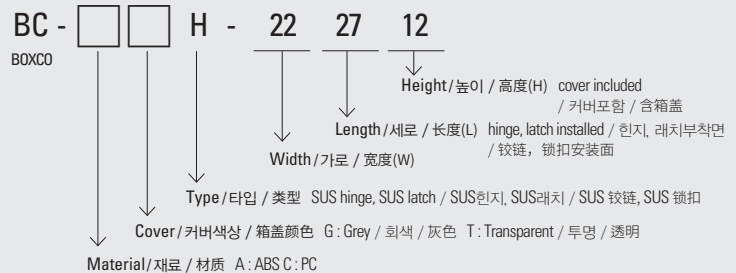

H Series - Medium and large size

H 시리즈 - 중·대형사이즈

H 系列 - 中·大型









(225x275x120~600x400x230mm)



Product model / 제품모델 / 产品型号				Mounting plate / 속판모델 / 底板型号			
Model 모델 / 型号	Size (W×L×H/mm) 사이즈 / 尺寸	Size(W×L×H/inch) 사이즈 / 尺寸	Inside depth(mm) 내부깊이 / 内部深度	Steel 철 / 金属	Plastic 플라스틱 / 塑料	Size(mm) 사이즈 / 尺寸	Size(inch) 사이즈 / 尺寸
BC-□□H-222712	225×275×120	8.86×10.83×4.72	103.6	2227S	2227P	190×242	7.48×9.53
BC-□□H-272212	275×225×120	10.83×8.86×4.72	103.6	2227S	2227P	190×242	7.48×9.53
BC-□□H-203015	200×300×150	7.87×11.81×5.91	133.6	2030S	2030P	166×266	6.54×10.47
BC-□□H-302015	300×200×150	11.81×7.87×5.91	133.6	2030S	2030P	166×266	6.54×10.47
BC-□□H-203018	200×300×180	7.87×11.81×7.09	163.6	2030S	2030P	166×266	6.54×10.47
BC-□□H-302018	300×200×180	11.81×7.87×7.09	163.6	2030S	2030P	166×266	6.54×10.47
BC-□□H-253515	250×350×150	9.84×13.78×5.91	133.6	2535S	2535P	216×316	8.50×12.44
BC-□□H-352515	350×250×150	13.78×9.84×5.91	133.6	2535S	2535P	216×316	8.50×12.44
BC-□□H-304015	300×400×150	11.81×15.75×5.91	133	3040S	3040P	265×365	10.43×14.37
BC-□□H-403015	400×300×150	15.75×11.81×5.91	133	3040S	3040P	265×365	10.43×14.37
BC-□□H-304018	300×400×180	11.81×15.75×7.09	163	3040S	3040P	265×365	10.43×14.37
BC-□□H-403018	400×300×180	15.75×11.81×7.09	163	3040S	3040P	265×365	10.43×14.37
BC-□□H-354516	350×450×160	13.78×17.72×6.30	143	3545S	3545P	306×407	12.05×16.02
BC-□□H-453516	450×350×160	17.72×13.78×6.30	143	3545S	3545P	306×407	12.05×16.02
BC-□□H-354520	350×450×200	13.78×17.72×7.87	183	3545S	3545P	306×407	12.05×16.02
BC-□□H-453520	450×350×200	17.72×13.78×7.87	183	3545S	3545P	306×407	12.05×16.02
BC-□□H-405020	400×500×200	15.75×19.69×7.87	182.4	4050S	4050P	358×458	14.09×18.03
BC-□□H-504020	500×400×200	19.69×15.75×7.87	182.4	4050S	4050P	358×458	14.09×18.03
BC-□□H-406023	400×600×230	15.75×23.62×9.06	212.4	4060S	4060P	358×558	14.09×21.97
BC-□□H-604023	600×400×230	23.62×15.75×9.06	212.4	4060S	4060P	358×558	14.09×21.97

※ BC-□□H-604023 is for non water proof product. / BC-□□H-604023은 비방수용입니다. / BC-□□H-604023是非防水用的型号.

▶ Accessories / 액세서리 / 配件

Steel mounting plate 	Plastic mounting plate 	Key ring(K40) 	Lock(SK) 
Plastic lock(PK) 	SUS bracket(B50,60) 	Plastic bracket(PB50) 	Vent(V60,80) 

▶ Dual door / 이중도어 / 双层门

Dual door applicable model / 이중도어 적용가능 제품 / 适用产品			Product model / 제품모델 / 产品型号		
Model 모델 / 型号	Size (W×L×H/mm) 사이즈 / 尺寸	Size(W×L×H/inch) 사이즈 / 尺寸	Dual door 이중도어 / 双层门系列	Dual door mounting plate 중판 / 内板	Dual door set 이중도어 세트 / 套装双 层门用配件
BC-□□H-405020	400×500×200	15.75×19.69×7.87	BC-F405020	BC-FA4050	BC-FA405020
BC-□□H-406023	400×500×230	15.75×23.62×9.06	BC-F406023	BC-FA4060	BC-FA406023

※ See page 56 / 56 페이지 참조 / 请参照第56页

H Series - Medium size

H 시리즈 - 중형사이즈

H 系列 - 中型









(190x190x130~560x380x180mm)



Product model / 제품모델 / 产品型号				Mounting plate / 속판모델 / 底板型号			
Model 모델 / 型号	Size (W×L×H/mm) 사이즈 / 尺寸	Size(W×L×H/inch) 사이즈 / 尺寸	Inside depth(mm) 내부깊이 / 内部深度	Steel 철 / 金属	Plastic 플라스틱 / 塑料	Size(mm) 사이즈 / 尺寸	Size(inch) 사이즈 / 尺寸
BC-□□H-191913	190×190×130	7.48×7.48×5.12	115	1919S	1919P	159×159	6.26×6.26
NEW BC-□□H-192810	190×280×100	7.48×11.02×3.94	84	1928S	1928P	159×248	6.26×9.76
NEW BC-□□H-281910	280×190×100	11.02×7.48×3.94	84	1928S	1928P	159×248	6.26×9.76
BC-□□H-192813	190×280×130	7.48×11.02×5.12	115	1928S	1928P	159×248	6.26×9.76
BC-□□H-281913	280×190×130	11.02×7.48×5.12	115	1928S	1928P	159×248	6.26×9.76
BC-□□H-192818	190×280×180	7.48×11.02×7.09	165	1928S	1928P	159×248	6.26×9.76
BC-□□H-281918	280×190×180	11.02×7.48×7.09	165	1928S	1928P	159×248	6.26×9.76
BC-□□H-193813	190×380×130	7.48×14.96×5.12	112	1938S	1938P	159×348	6.26×13.70
BC-□□H-381913	380×190×130	14.96×7.48×5.12	112	1938P	1938P	159×348	6.26×13.70
BC-□□H-193818	190×380×180	7.48×14.96×7.09	159	1938S	1938P	159×348	6.26×13.70
BC-□□H-381918	380×190×180	14.96×7.48×7.09	159	1938S	1938P	159×348	6.26×13.70
BC-□□H-282813	280×280×130	11.02×11.02×5.12	112	2828S	2828P	248×248	9.76×9.76
BC-□□H-283413	280×340×130	11.02×13.39×5.12	112	2834S	2834P	248×308	9.76×12.12
BC-□□H-342813	340×280×130	13.39×11.02×5.12	112	2834S	2834P	248×308	9.76×12.12
BC-□□H-283813	280×380×130	11.02×14.96×5.12	112	2838S	2838P	248×348	9.76×13.70
BC-□□H-382813	380×280×130	14.96×11.02×5.12	112	2838S	2838P	248×348	9.76×13.70
BC-□□H-283818	280×380×180	11.02×14.96×7.09	161.6	2838S	2838P	248×348	9.76×13.70
BC-□□H-382818	380×280×180	14.96×11.02×7.09	161.6	2838S	2838P	248×348	9.76×13.70
BC-□□H-285613	280×560×130	11.02×22.05×5.12	112	2856S	-	(232)×(535)	(9.13)×(21.06)
BC-□□H-562813	560×280×130	22.05×11.02×5.12	112	2856S	-	(232)×(535)	(9.13)×(21.06)
BC-□□H-334318	330×430×180	12.99×16.93×7.09	160.8	3343S	3343P	(295)×(395)	(11.61)×(15.55)
BC-□□H-433318	430×330×180	16.93×12.99×7.09	160.8	3343S	3343P	(295)×(395)	(11.61)×(15.55)
BC-□□H-385618	380×560×180	14.96×22.05×7.09	160.8	3856S	-	(345)×(535)	(13.58)×(21.06)
BC-□□H-563818	560×380×180	22.05×14.96×7.09	160.8	3856S	-	(345)×(535)	(13.58)×(21.06)

* BC-□□H-563818 is for non water proof product. / BC-□□H-563818은 비방수용입니다. / BC-□□H-563818是非防水用的型号.

▶ **Accessories / 액세서리 / 配件**

Steel mounting plate 	Plastic mounting plate 	Key ring(K40) 	Lock(SK) 
Plastic lock(PK) 	SUS bracket(B50) 	Plastic bracket(PB50) 	Vent(V60,80) 

H Series - Small size

H 시리즈 - 소형사이즈

H 系列 - 小型







(80x110x70~230x210x100mm)



Product model / 제품모델 / 产品型号				Mounting plate / 속판모델 / 底板型号			
Model 모델 / 型号	Size (W×L×H/mm) 사이즈 / 尺寸	Size(WxLxH/inch) 사이즈 / 尺寸	Inside depth(mm) 내부깊이 / 内部深度	Steel 철 / 金属	Plastic 플라스틱 / 塑料	Size(mm) 사이즈 / 尺寸	Size(inch) 사이즈 / 尺寸
BC-□□H-081107	80×110× 70	3.15×4.33×2.76	57	0811S	0811P	64×94	2.52×3.70
BC-□□H-110807	110×80× 70	4.33×3.15×2.76	57	0811S	0811P	64×94	2.52×3.70
BC-□□H-081108	80×110× 85	3.15×4.33×3.35	72	0811S	0811P	64×94	2.52×3.70
BC-□□H-110808	110×80× 85	4.33×3.15×3.35	72	0811S	0811P	64×94	2.52×3.70
BC-□□H-081110	80×110×100	3.15×4.33×3.94	87	0811S	0811P	64×94	2.52×3.70
BC-□□H-110810	110×80×100	4.33×3.15×3.94	87	0811S	0811P	64×94	2.52×3.70
BC-□□H-081307	80×130×70	3.15×5.12×2.76	57	0813S	0813P	65×115	2.56×4.53
BC-□□H-130807	130×80×70	5.12×3.15×2.76	57	0813P	0813P	65×115	2.56×4.53
BC-□□H-081308	80×130×85	3.15×5.12×3.35	72	0813S	0813P	65×115	2.56×4.53
BC-□□H-130808	130×80×85	5.12×3.15×3.35	72	0813S	0813P	65×115	2.56×4.53
BC-□□H-081807	80×180×70	3.15×7.09×2.76	57	0818S	0818P	65×165	2.56×6.50
BC-□□H-180807	180×80×70	7.09×3.15×2.76	57	0818S	0818P	65×165	2.56×6.50
BC-□□H-081808	80×180×85	3.15×7.09×3.35	72	0818S	0818P	65×165	2.56×6.50
BC-□□H-180808	180×80×85	7.09×3.15×3.35	72	0818S	0818P	65×165	2.56×6.50
BC-□□H-082507	80×250×70	3.15×9.84×2.76	57	0825S	0825P	65×235	2.56×9.25
BC-□□H-250807	250×80×70	9.84×3.15×2.76	57	0825S	0825P	65×235	2.56×9.25
BC-□□H-082508	80×250×85	3.15×9.84×3.35	72	0825S	0825P	65×235	2.56×9.25
BC-□□H-250808	250×80×85	9.84×3.15×3.35	72	0825S	0825P	65×235	2.56×9.25
BC-□□H-101007	100×100× 75	3.94×3.94×2.95	61.6	1010S	1010P	82×82	3.23×3.23
BC-□□H-101010	100×100×100	3.94×3.94×3.94	86.6	1010S	1010P	82×82	3.23×3.23
BC-□□H-121207	125×125× 75	4.92×4.92×2.95	60.5	1212S	1212 P	107×107	4.21×4.21
BC-□□H-121210	125×125×100	4.92×4.92×3.94	85.8	1212S	1212P	107×107	4.21×4.21
BC-□□H-121707	125×175×75	4.92×6.89×2.95	61.6	1217S	1217P	113×161	4.45×6.34
BC-□□H-171207	175×125×75	6.89×4.92×2.95	61.6	1217S	1217P	113×161	4.45×6.34
BC-□□H-121710	125×175×100	4.92×6.89×3.94	86.6	1217S	1217P	113×161	4.45×6.34
BC-□□H-171210	175×125×100	6.89×4.92×3.94	86.6	1217S	1217P	113×161	4.45×6.34
BC-□□H-141709	140×170×95	5.51×6.69×3.74	81.6	1417S	1417P	126×155	4.96×6.10
BC-□□H-171409	170×140×95	6.69×5.51×3.74	81.6	1714S	1714P	126×155	4.96×6.10
BC-□□H-142309	140×230×95	5.51×9.06×3.74	81.6	1423S	1423P	122×212	4.80×8.35
BC-□□H-231409	230×140×95	9.06×5.51×3.74	77	1423S	1423P	122×212	4.80×8.35
BC-□□H-151507	150×150×75	5.91×5.91×2.95	61.6	1515S	1515P	123×123	4.84×4.84
BC-□□H-151510	150×150×100	5.91×5.91×3.94	86.6	1515S	1515P	123×123	4.84×4.84
BC-□□H-152007	150×200×75	5.91×7.87×2.95	61.6	1520S	1520P	129×179	5.08×7.05
BC-□□H-201507	200×150×75	7.87×5.91×2.95	61.6	1520S	1520P	129×179	5.08×7.05
BC-□□H-152010	150×200×100	5.91×7.87×3.94	86.6	1520S	1520P	129×179	5.08×7.05
BC-□□H-201510	200×150×100	7.87×5.91×3.94	86.6	1520S	1520P	129×179	5.08×7.05
BC-□□H-152013	150×200×130	5.91×7.87×5.12	117.6	1520S	1520P	129×179	5.08×7.05
BC-□□H-201513	200×150×130	7.87×5.91×5.12	117.6	1520S	1520P	129×179	5.08×7.05
BC-□□H-152016	150×200×160	5.91×7.87×6.30	146.6	2020S	2020P	129×179	5.08×7.05

Product model / 제품모델 / 产品型号				Mounting plate / 속판모델 / 底板型号			
Model 모델 / 型号	Size (W×L×H/mm) 사이즈 / 尺寸	Size(W×L×H/inch) 사이즈 / 尺寸	Inside depth(mm) 내부깊이 / 内部深度	Steel 철 / 金属	Plastic 플라스틱 / 塑料	Size(mm) 사이즈 / 尺寸	Size(inch) 사이즈 / 尺寸
BC-□□H-201516	200×150×160	7.87×5.91×6.30	146.6	2020S	2020P	129×179	5.08×7.05
BC-□□H-152510	150×250×100	5.91×9.84×3.94	86.6	1525S	1525P	129×224	5.08×8.82
BC-□□H-251510	250×150×100	9.84×5.91×3.94	86.6	1525S	1525P	129×224	5.08×8.82
BC-□□H-152513	150×250×130	5.91×9.84×5.12	116.6	1525S	1525P	129×224	5.08×8.82
BC-□□H-251513	250×150×130	9.84×5.91×5.12	116.6	1525S	1525P	129×224	5.08×8.82
BC-□□H-202010	200×200×100	7.87×7.87×3.94	84	2020S	2020P	179×179	7.05×7.05
BC-□□H-202013	200×200×130	7.87×7.87×5.12	114	2020S	2020P	179×179	7.05×7.05
BC-□□H-202016	200×200×160	7.87×7.87×6.30	144	2020S	2020P	179×179	7.05×7.05
BC-□□H-202019	200×200×190	7.87×7.87×7.48	174	2020S	2020P	179×179	7.05×7.05
BC-□□H-212310	210×230×100	8.27×9.06×3.94	84	2123S	-	196.5×216	7.74×8.50
BC-□□H-232110	230×210×100	9.06×8.27×3.94	84	2123S	-	196.5×216	7.74×8.50

▶ **Accessories / 액세서리 / 配件**

Steel mounting plate 	Plastic mounting plate(ABS) 	Key ring(K40) 	Lock(SK) 
Plastic lock(PK) 	SUS bracket(B40) 	Plastic bracket(PB40) 	Vent(V60,80) 