

# P series

P 시리즈 / P 系列

(90x120x70 ~ 630x830x285mm)

### • Feature / 특성 / 特征

- 1. SUS hinge pin, SUS latch and insert
- 2. It is easy to removable cover and body
- 1. 스텐레스 힌지핀, 스텐레스 래치, 인서트 있는 제품
- 2. 커버, 베이스 탈부착 용이
- 1. SUS铰链柱, 采用SUS锁扣 螺母的产品
- 2. 容易分开盒体和盒盖

### • Specification / 사양 / 产品规格说明

Temperature range / 온도영역 / 温度范围

ABS : - 40 ~ + 70, PC : - 40 ~ + 110

Flammability Rating / 난연성 / 难燃性

ABS : 94-HB, PC : 94-V-0, 5VA, 94-HB

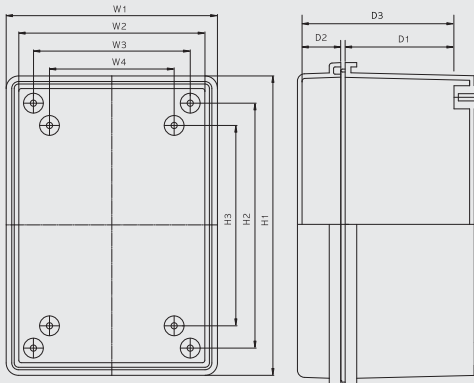

### • P Series model name / P시리즈 모델선정방법 / P系列 产品型号命名方法

BC -   P - 09 12 07

BOXCO

↓ ↓ ↓ ↓ ↓ ↓

Material/재료 / 材质 A: ABS C: PC

↓

Cover/커버색상 / 箱盖颜色 G: Grey / 회색 / 灰色 T: Transparent / 투명 / 透明

↓

Type/타입 / 类型 SUS latch / SUS 래치 / SUS 锁扣

↓

Width/가로 / 宽度(W)

↓

Length/세로 / 长度(L) hinge, latch installed / 힌지, 래치부착면 / 铰链, 锁扣安装面









↓

Height/높이 / 高度(H) cover included / 커버포함 / 含箱盖

| Product model / 제품모델 / 产品型号 |                             |                              |                                 | Mounting plate / 속판모델 / 底板型号 |                      |                      |                        |
|-----------------------------|-----------------------------|------------------------------|---------------------------------|------------------------------|----------------------|----------------------|------------------------|
| Model<br>모델 / 型号            | Size (WxLxH/mm)<br>사이즈 / 尺寸 | Size(WxLxH/inch)<br>사이즈 / 尺寸 | Inside depth(mm)<br>내부깊이 / 内部深度 | Steel<br>철 / 金属              | Plastic<br>플라스틱 / 塑料 | Size(mm)<br>사이즈 / 尺寸 | Size(inch)<br>사이즈 / 尺寸 |
| BC-□□P-091207               | 90×120×70                   | 3.54×4.72×2.76               | 56.6                            | 0912S                        | 0811P                | 65×95                | 2.56×3.74              |
| BC-□□P-091208               | 90×120×85                   | 3.54×4.72×3.35               | 71.6                            | 0912S                        | 0811P                | 65×95                | 2.56×3.74              |
| BC-□□P-101507               | 100×150×70                  | 3.94×5.91×2.76               | 56.6                            | 0813S                        | 0813P                | 65×115               | 2.56×4.53              |
| BC-□□P-101508               | 100×150×85                  | 3.94×5.91×3.35               | 71.6                            | 0813S                        | 0813P                | 65×115               | 2.56×4.53              |
| BC-□□P-112107               | 110×210×75                  | 4.33×8.27×2.95               | 61.6                            | 1020S                        | 1020P                | 88×189               | 3.46×7.44              |
| BC-□□P-112110               | 110×210×100                 | 4.33×8.27×3.94               | 86.6                            | 1020S                        | 1020P                | 88×189               | 3.46×7.44              |
| BC-□□P-112607               | 110×260×75                  | 4.33×10.24×2.95              | 61.6                            | 1126S                        | 1126P                | 85×232               | 3.35×9.13              |
| BC-□□P-112610               | 110×260×100                 | 4.33×10.24×3.94              | 86.6                            | 1126S                        | 1126P                | 85×232               | 3.35×9.13              |
| BC-□□P-131508               | 135×155×85                  | 5.12×5.91×3.35               | 71.6                            | 1315S                        | 1315P                | 101×126              | 3.98×4.96              |
| BC-□□P-131808               | 135×185×85                  | 5.12×7.09×3.35               | 71.6                            | 1217S                        | 1217P                | 113×161              | 4.45×6.34              |
| BC-□□P-131810               | 135×185×100                 | 5.12×7.09×3.94               | 86.6                            | 1217S                        | 1217P                | 113×161              | 4.45×6.34              |
| BC-□□P-151509               | 150×150×90                  | 5.91×5.91×3.54               | 76                              | 1515S                        | 1515P                | 123×123              | 4.84×4.84              |
| BC-□□P-151512               | 150×150×120                 | 5.91×5.91×4.72               | 106                             | 1515S                        | 1515P                | 123×123              | 4.84×4.84              |
| BC-□□P-162110               | 160×210×100                 | 6.30×8.27×3.94               | 86.6                            | 1520S                        | 1520P                | 129×179              | 5.08×7.05              |
| BC-□□P-162113               | 160×210×130                 | 6.30×8.27×5.12               | 116.6                           | 1520S                        | 1520P                | 129×179              | 5.08×7.05              |
| BC-□□P-162610               | 160×260×100                 | 6.30×10.24×3.94              | 86.6                            | 1525S                        | 1525P                | 129×224              | 5.08×8.82              |
| BC-□□P-162613               | 160×260×130                 | 6.30×10.24×5.12              | 116.6                           | 1525S                        | 1525P                | 129×224              | 5.08×8.82              |
| BC-□□P-172211               | 170×220×110                 | 6.69×8.66×4.33               | 95.6                            | 1520S                        | 1520P                | 129×179              | 5.08×7.05              |
| BC-□□P-172711               | 170×270×110                 | 6.69×10.63×4.33              | 95.6                            | 1525S                        | 1525P                | 129×224              | 5.08×8.82              |
| BC-□□P-212110               | 210×210×100                 | 8.27×8.27×3.94               | 86.6                            | 2020S                        | 2020P                | 179×179              | 7.05×7.05              |
| BC-□□P-212113               | 210×210×130                 | 8.27×8.27×5.12               | 123.6                           | 2020S                        | 2020P                | 179×179              | 7.05×7.05              |
| BC-□□P-192810               | 190×280×100                 | 7.48×11.02×3.94              | 83.6                            | 1928S                        | 1928P                | 159×248              | 6.26×9.76              |
| BC-□□P-192814               | 190×280×140                 | 7.48×11.02×5.51              | 123.6                           | 1928S                        | 1928P                | 159×248              | 6.26×9.76              |
| BC-□□P-203013               | 200×300×130                 | 7.87×11.81×5.12              | 113.6                           | 2030S                        | 2030P                | 166×266              | 6.54×10.47             |
| BC-□□P-203015               | 200×300×150                 | 7.87×11.81×5.91              | 133.6                           | 2030S                        | 2030P                | 166×266              | 6.54×10.47             |
| BC-□□P-203018               | 200×300×180                 | 7.87×11.81×7.09              | 163.6                           | 2030S                        | 2030P                | 166×266              | 6.54×10.47             |
| BC-□□P-253515               | 250×350×150                 | 9.84×13.78×5.91              | 133.6                           | 2535S                        | 2535P                | 216×316              | 8.50×12.44             |
| BC-□□P-253518               | 250×350×180                 | 9.84×13.78×7.09              | 163.6                           | 2535S                        | 2535P                | 216×316              | 8.50×12.44             |
| BC-□□P-282813               | 280×280×130                 | 11.02×11.02×5.12             | 113.6                           | 2828S                        | 2828P                | 248×248              | 9.76×9.76              |
| BC-□□P-283813               | 280×380×130                 | 11.02×14.96×5.12             | 113.6                           | 2838S                        | 2838P                | 248×348              | 9.76×13.7              |
| BC-□□P-303015               | 300×300×150                 | 11.81×11.81×5.91             | 133.6                           | 3030S                        | 3030P                | 262×262              | 10.31×10.31            |
| BC-□□P-303018               | 300×300×180                 | 11.81×11.81×7.09             | 163.6                           | 3030S                        | 3030P                | 262×262              | 10.31×10.31            |
| BC-□□P-304012               | 300×400×120                 | 11.81×15.75×4.72             | 103.6                           | 3040S                        | 3040P                | 265×365              | 10.43×14.37            |
| BC-□□P-304015               | 300×400×150                 | 11.81×15.75×5.91             | 133.6                           | 3040S                        | 3040P                | 265×365              | 10.43×14.37            |
| BC-□□P-304018               | 300×400×180                 | 11.81×15.75×7.09             | 163.6                           | 3040S                        | 3040P                | 265×365              | 10.43×14.37            |
| BC-□□P-353515               | 350×350×150                 | 13.78×13.78×5.91             | 133.6                           | 3535S                        | 3535P                | 320×320              | 12.60×12.60            |
| BC-□□P-353518               | 350×350×180                 | 13.78×13.78×7.09             | 163.6                           | 3535S                        | 3535P                | 320×320              | 12.60×12.60            |
| BC-□□P-354512               | 350×450×120                 | 13.78×17.72×4.72             | 102.6                           | 3545S                        | 3545P                | 306×407              | 12.05×16.02            |
| BC-□□P-354516               | 350×450×160                 | 13.78×17.72×6.30             | 142.6                           | 3545S                        | 3545P                | 306×407              | 12.05×16.02            |
| BC-□□P-354520               | 350×450×200                 | 13.78×17.72×7.87             | 182.6                           | 3545S                        | 3545P                | 306×407              | 12.05×16.02            |
| BC-□□P-405016               | 400×500×160                 | 15.75×19.69×6.30             | 144                             | 4050S                        | 4050P                | 358×458              | 14.09×18.03            |
| BC-□□P-405020               | 400×500×200                 | 15.75×19.69×7.87             | 183.6                           | 4050S                        | 4050P                | 358×458              | 14.09×18.03            |
| BC-□□P-406018               | 400×600×180                 | 15.75×23.62×7.09             | 163.6                           | 4060S                        | 4060P                | 358×558              | 14.09×21.97            |
| BC-□□P-406023               | 400×600×230                 | 15.75×23.62×9.06             | 213.6                           | 4060S                        | 4060P                | 358×558              | 14.09×21.97            |

| Product model / 제품모델 / 产品型号 |                             |                              |                                 | Mounting plate / 속판모델 / 底板型号 |                      |                      |                        |
|-----------------------------|-----------------------------|------------------------------|---------------------------------|------------------------------|----------------------|----------------------|------------------------|
| Model<br>모델 / 型号            | Size (WxLxH/mm)<br>사이즈 / 尺寸 | Size(WxLxH/inch)<br>사이즈 / 尺寸 | Inside depth(mm)<br>내부깊이 / 内部深度 | Steel<br>철 / 金属              | Plastic<br>플라스틱 / 塑料 | Size(mm)<br>사이즈 / 尺寸 | Size(inch)<br>사이즈 / 尺寸 |
| BC-□□P-506018               | 530x630x185                 | 20.87x24.80x7.28             | 166                             | 5060S                        | 5060P                | 450x555              | 17.72x21.85            |
| BC-□□P-506025               | 530x630x255                 | 20.87x24.80x10.04            | 236                             | 5060S                        | 5060P                | 450x555              | 17.72x21.85            |
| BC-□□P-507018               | 530x730x185                 | 20.87x28.74x7.28             | 166                             | 5070S                        | 5070P                | 450x655              | 17.72x25.79            |
| BC-□□P-507025               | 530x730x255                 | 20.87x28.74x10.04            | 236                             | 5070S                        | 5070P                | 450x655              | 17.72x25.79            |
| BC-□□P-608018               | 630x830x185                 | 24.80x32.68x7.28             | 166                             | 6080S                        | -                    | 550x755              | 21.65x29.72            |
| BC-□□P-608028               | 630x830x285                 | 24.80x32.68x11.22            | 266                             | 6080S                        | -                    | 550x755              | 21.65x29.72            |

▣ Accessories / 액세서리 / 配件

| Steel mounting plate   | Plastic mounting plate   | Key Ring(K40)  | Lock(SK)  | Plastic lock(PK)  |
|--|--|--|---|---|
|   |   |   |   |  |
| Integral lock(PSK20,35,50)   | SUS bracket(B40,50,60)   | Plastic bracket(PB40,50)   | Vent(V60,80)  |   |
|  |  |  |  |   |

▣ Dual door / 이중도어 / 双层门

| Dual door applicable model / 이중도어 적용가능 제품 / 适用产品 |                             |                              | Product model / 제품모델 / 产品型号 |  |   |
|--|-----------------------------|------------------------------|-----------------------------|--|---|
| Model<br>모델 / 型号                                 | Size (WxLxH/mm)<br>사이즈 / 尺寸 | Size(WxLxH/inch)<br>사이즈 / 尺寸 | Dual door<br>이중도어 / 双层门系列   | Dual door mounting<br>plate<br>중판 / 内板 | Dual door set<br>이중도어 세트 / 套装双<br>层门用配件 |
| BC-□□P-203013                                    | 200x300x130                 | 7.87x11.81x5.12              | BC-F203013                  | BC-FA2030                              | BC-FA203013                             |
| BC-□□P-203015                                    | 200x300x150                 | 7.87x11.81x5.91              | BC-F203015                  | BC-FA2030                              | BC-FA203015                             |
| BC-□□P-203018                                    | 200x300x180                 | 7.87x11.81x7.09              | BC-F203018                  | BC-FA2030                              | BC-FA203018                             |
| BC-□□P-253515                                    | 250x350x150                 | 9.84x13.78x5.91              | BC-F253515                  | BC-FA2535                              | BC-FA253515                             |
| BC-□□P-253518                                    | 250x350x180                 | 9.84x13.78x7.09              | BC-F253518                  | BC-FA2535                              | BC-FA253518                             |
| BC-□□P-282813                                    | 280x280x130                 | 11.02x11.02x5.12             | BC-F282813                  | BC-FA2828                              | BC-FA282813                             |
| BC-□□P-283813                                    | 280x380x130                 | 11.02x14.96x5.12             | BC-F283813                  | BC-FA2838                              | BC-FA283813                             |
| BC-□□P-303015                                    | 300x300x150                 | 11.81x11.81x5.91             | BC-F303015                  | BC-FA3030                              | BC-FA303015                             |
| BC-□□P-303018                                    | 300x300x180                 | 11.81x11.81x7.09             | BC-F303018                  | BC-FA3030                              | BC-FA303018                             |
| BC-□□P-304015                                    | 300x400x150                 | 11.81x15.75x5.91             | BC-F304015                  | BC-FA3040                              | BC-FA304015                             |
| BC-□□P-304018                                    | 300x400x180                 | 11.81x15.75x7.09             | BC-F304018                  | BC-FA3040                              | BC-FA304018                             |
| BC-□□P-354516                                    | 350x450x160                 | 13.78x17.72x6.30             | BC-F354516                  | BC-FA3545                              | BC-FA354516                             |
| BC-□□P-354520                                    | 350x450x200                 | 13.78x17.72x7.87             | BC-F354520                  | BC-FA3545                              | BC-FA354520                             |
| BC-□□P-405016                                    | 400x500x160                 | 15.75x19.69x6.30             | BC-F405016                  | BC-FA4050                              | BC-FA405016                             |
| BC-□□P-405020                                    | 400x500x200                 | 15.75x19.69x7.87             | BC-F405020                  | BC-FA4050                              | BC-FA405020                             |
| BC-□□P-406018                                    | 400x600x180                 | 15.75x23.62x7.09             | BC-F406018                  | BC-FA4060                              | BC-FA406018                             |
| BC-□□P-406023                                    | 400x600x230                 | 15.75x23.62x9.06             | BC-F406023                  | BC-FA4060                              | BC-FA406023                             |
| BC-□□P-506018                                    | 530x630x185                 | 20.87x24.80x7.28             | BC-F506018                  | BC-FA5060                              | BC-FA506018                             |
| BC-□□P-506025                                    | 530x630x255                 | 20.87x24.80x10.04            | BC-F506025                  | BC-FA5060                              | BC-FA506025                             |