

Terminal block box

단자박스 / 端子盒

Obtained TUV / TUV 획득 / 获得德国TUV认证

• Specification / 사양 / 产品规格说明

IP rating / 방수, 방진 보호등급 / 防尘防水等级
IP 66 / 67
IK Rating / 충격 테스트 / 冲击测试
IK 07 / 08
Rated Insulation Voltage / 절연정격전압 / 正常耐压
400V
Rated Current Capacity / 정격전류용량 / 正常电流量
0.75mm sq. - 1.5mm sq.
Temperature range / 온도영역 / 温度范围
ABS : - 40 ~ + 70, PC : - 40 ~ + 110
Flammability Rating / 난연성 / 难燃性
ABS : 94-V-0, PC/ABS : 94-V-0, 5VA

• Terminal block box model name / 단자박스 모델선정방법 / 端子盒 产品型号命名方法

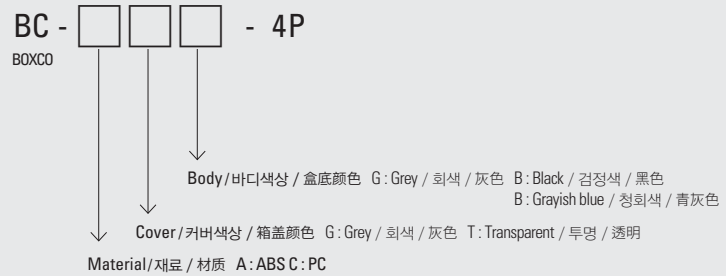

▶ 4P



BASE

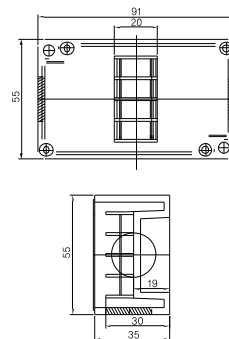

COVER

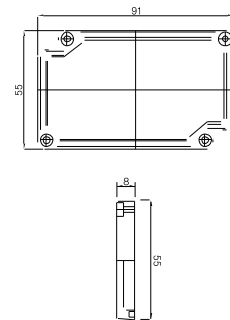

Model size / 모델사이즈 / 型号尺寸		Product model / 제품모델 / 产品型号					
Size (WxLxH/mm) 사이즈 / 尺寸	Size(WxLxH/inch) 사이즈 / 尺寸	ABS Grey ABS회색 / ABS灰色		ABS Grayish blue ABS청회색 / ABS青灰色		PC/ABS Grey PC/ABS회색 / PC/ABS灰色	
		Opaque 불투명 / 不透明	Transparent 투명 / 透明	Opaque 불투명 / 不透明	Transparent 투명 / 透明	Opaque 불투명 / 不透明	Transparent 투명 / 透明
55x91x43x21(Knock out)	2.17x3.58x1.69	BC-AGG-4P	BC-ATG-4P	BC-AGB-4P	BC-ATB-4P	BC-PGG-4P	BC-PTG-4P

▶ 4PH

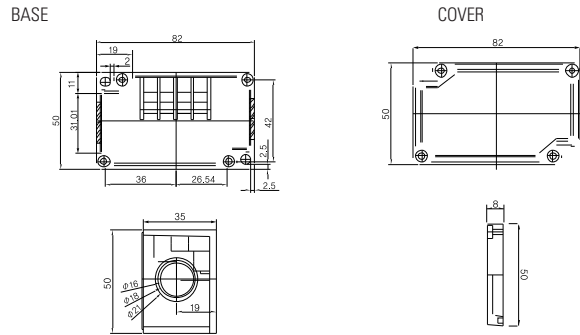

Model size / 모델사이즈 / 型号尺寸		Product model / 제품모델 / 产品型号					
Size (W×L×H/mm) 사이즈 / 尺寸	Size(W×L×H/inch) 사이즈 / 尺寸	ABS Grey ABS회색 / ABS灰色		ABS Grayish blue ABS청회색 / ABS青灰色		PC/ABS Grey PC/ABS회색 / PC/ABS灰色	
		Opaque 불투명 / 不透明	Transparent 투명 / 透明	Opaque 불투명 / 不透明	Transparent 투명 / 透明	Opaque 불투명 / 不透明	Transparent 투명 / 透明
50×82×43(Knock out)	1.97x3.23x1.69	BC-AGG-4PH	BC-ATG-4PH	BC-AGB-4PH	BC-ATB-4PH	BC-PGG-4PH	BC-PTG-4PH

▶ 4PT

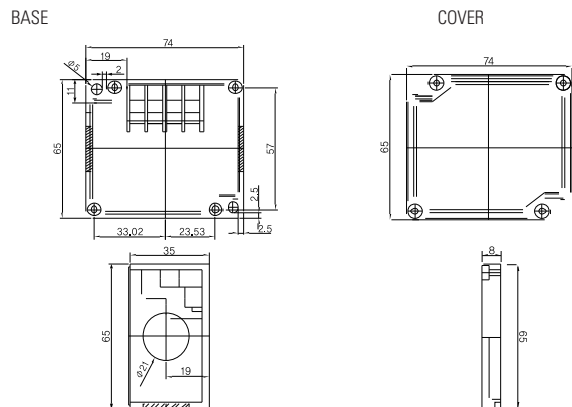

Model size / 모델사이즈 / 型号尺寸		Product model / 제품모델 / 产品型号					
Size (W×L×H/mm) 사이즈 / 尺寸	Size(W×L×H/inch) 사이즈 / 尺寸	ABS Grey ABS회색 / ABS灰色		ABS Grayish blue ABS청회색 / ABS青灰色		PC/ABS Grey PC/ABS회색 / PC/ABS灰色	
		Opaque 불투명 / 不透明	Transparent 투명 / 透明	Opaque 불투명 / 不透明	Transparent 투명 / 透明	Opaque 불투명 / 不透明	Transparent 투명 / 透明
65×74×43(Knock out)	2.56×2.91×1.69	BC-AGG-4PT	BC-ATG-4PT	BC-AGB-4PT	BC-ATB-4PT	BC-PGG-4PT	BC-PTG-4PT

▶ 6P

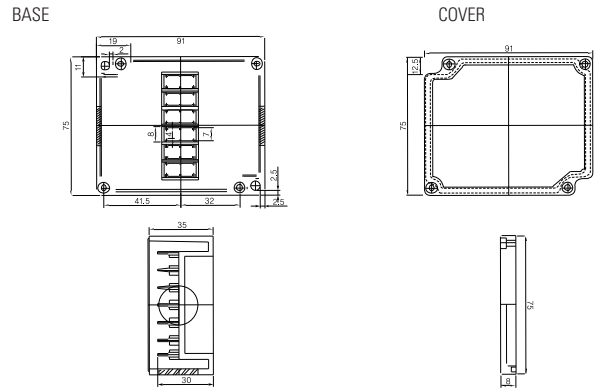

Model size / 모델사이즈 / 型号尺寸		Product model / 제품모델 / 产品型号					
Size (W×L×H/mm) 사이즈 / 尺寸	Size(W×L×H/inch) 사이즈 / 尺寸	ABS Grey ABS회색 / ABS灰色		ABS Grayish blue ABS청회색 / ABS青灰色		PC/ABS Grey PC/ABS회색 / PC/ABS灰色	
		Opaque 불투명 / 不透明	Transparent 투명 / 透明	Opaque 불투명 / 不透明	Transparent 투명 / 透明	Opaque 불투명 / 不透明	Transparent 투명 / 透明
75×91×43×21(Knock out)	2.95×3.58×1.69	BC-AGG-6P	BC-ATG-6P	BC-AGB-6P	BC-ATB-6P	BC-PGG-6P	BC-PTG-6P

▶ 6PH

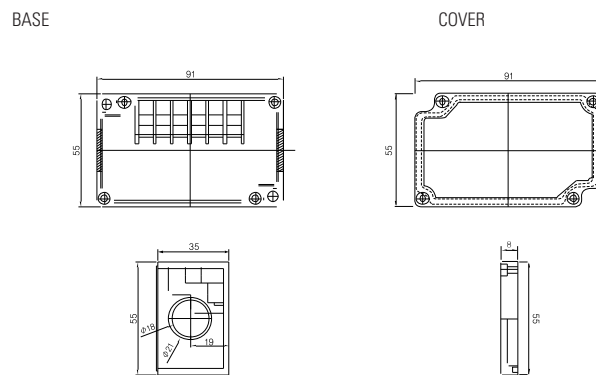

Model size / 모델사이즈 / 型号尺寸		Product model / 제품모델 / 产品型号					
Size (W×L×H/mm) 사이즈 / 尺寸	Size(W×L×H/inch) 사이즈 / 尺寸	ABS Grey ABS회색 / ABS灰色		ABS Grayish blue ABS청회색 / ABS青灰色		PC/ABS Grey PC/ABS회색 / PC/ABS灰色	
		Opaque 불투명 / 不透明	Transparent 투명 / 透明	Opaque 불투명 / 不透明	Transparent 투명 / 透明	Opaque 불투명 / 不透明	Transparent 투명 / 透明
55×91×43×21(Knock out)	2.17×3.58×1.69	BC-AGG-6PH	BC-ATG-6PH	BC-AGB-6PH	BC-ATB-6PH	BC-PGG-6PH	BC-PTG-6PH

▶ 6PT

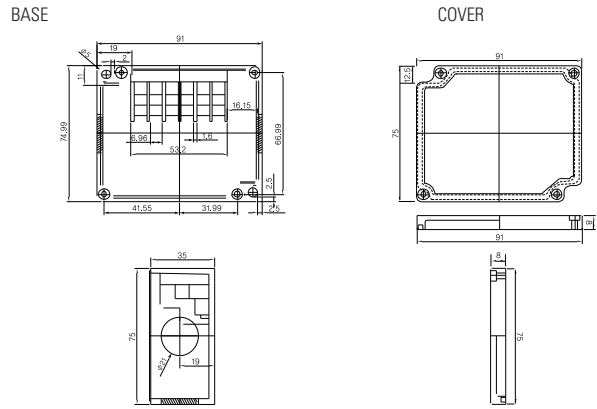

Model size / 모델사이즈 / 型号尺寸		Product model / 제품모델 / 产品型号					
Size (WxLxH/mm) 사이즈 / 尺寸	Size(WxLxH/inch) 사이즈 / 尺寸	ABS Grey ABS회색 / ABS灰色		ABS Grayish blue ABS청회색 / ABS青灰色		PC/ABS Grey PC/ABS회색 / PC/ABS灰色	
		Opaque 불투명 / 不透明	Transparent 투명 / 透明	Opaque 불투명 / 不透明	Transparent 투명 / 透明	Opaque 불투명 / 不透明	Transparent 투명 / 透明
75x91x43(Knock out)	2.95x3.58x1.69	BC-AGG-6PT	BC-ATG-6PT	BC-AGB-6PT	BC-ATB-6PT	BC-PGG-6PT	BC-PTG-6PT

▶ 10P

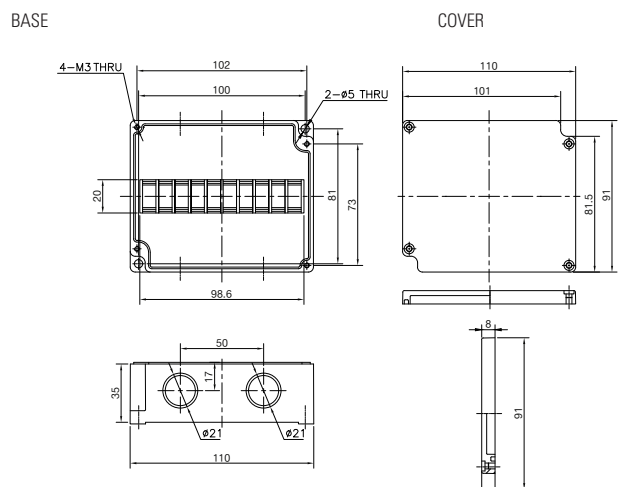

Model size / 모델사이즈 / 型号尺寸		Product model / 제품모델 / 产品型号					
Size (WxLxH/mm) 사이즈 / 尺寸	Size(WxLxH/inch) 사이즈 / 尺寸	ABS Grey ABS회색 / ABS灰色		ABS Grayish blue ABS청회색 / ABS青灰色		PC/ABS Grey PC/ABS회색 / PC/ABS灰色	
		Opaque 불투명 / 不透明	Transparent 투명 / 透明	Opaque 불투명 / 不透明	Transparent 투명 / 透明	Opaque 불투명 / 不透明	Transparent 투명 / 透明
91x110x43(Knock out)	3.58x4.01x1.69	BC-AGG-10P	BC-ATG-10P	BC-AGB-10P	BC-ATB-10P	BC-PGG-10P	BC-PTG-10P

▶ 10PT



BASE

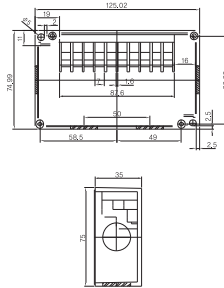

COVER

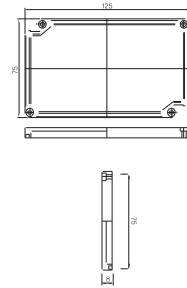

Model size / 모델사이즈 / 型号尺寸		Product model / 제품모델 / 产品型号					
Size (W×L×H/mm) 사이즈 / 尺寸	Size(WxLxH/inch) 사이즈 / 尺寸	ABS Grey ABS회색 / ABS灰色		ABS Grayish blue ABS청회색 / ABS青灰色		PC/ABS Grey PC/ABS회색 / PC/ABS灰色	
		Opaque 불투명 / 不透明	Transparent 투명 / 透明	Opaque 불투명 / 不透明	Transparent 투명 / 透明	Opaque 불투명 / 不透明	Transparent 투명 / 透明
75×125×43×21(Knock out)	2.95×4.92×1.69	BC-AGG-10PT	BC-ATG-10PT	BC-AGB-10PT	BC-ATB-10PT	BC-PGG-10PT	BC-PTG-10PT

▶ 15P



BASE

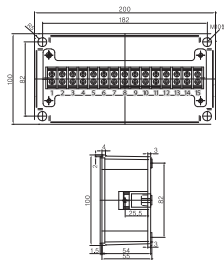

COVER

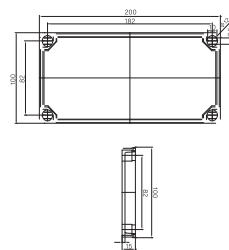

Model size / 모델사이즈 / 型号尺寸		Product model / 제품모델 / 产品型号					
Size (W×L×H/mm) 사이즈 / 尺寸	Size(WxLxH/inch) 사이즈 / 尺寸	ABS Grey ABS회색 / ABS灰色		ABS Grayish blue ABS청회색 / ABS青灰色		PC/ABS Grey PC/ABS회색 / PC/ABS灰色	
		Opaque 불투명 / 不透明	Transparent 투명 / 透明	Opaque 불투명 / 不透明	Transparent 투명 / 透明	Opaque 불투명 / 不透明	Transparent 투명 / 透明
100×185×70	3.94×7.28×2.76	BC-AGG-15P	BC-ATG-15P	BC-AGB-15P	BC-ATB-15P	BC-PGG-15P	BC-PTG-15P

▶ 15PT



BASE

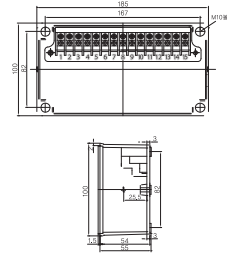

COVER

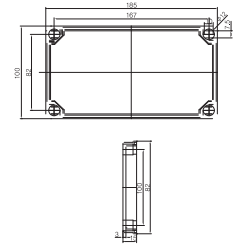

Model size / 모델사이즈 / 型号尺寸		Product model / 제품모델 / 产品型号					
Size (W×L×H/mm) 사이즈 / 尺寸	Size(W×L×H/inch) 사이즈 / 尺寸	ABS Grey ABS회색 / ABS灰色		ABS Grayish blue ABS청회색 / ABS青灰色		PC/ABS Grey PC/ABS회색 / PC/ABS灰色	
		Opaque 불투명 / 不透明	Transparent 투명 / 透明	Opaque 불투명 / 不透明	Transparent 투명 / 透明	Opaque 불투명 / 不透明	Transparent 투명 / 透明
100×185×70	3.94×7.28×2.76	BC-AGG-15PT	BC-ATG-15PT	BC-AGB-15PT	BC-ATB-15PT	BC-PGG-15PT	BC-PTG-15PT

▶ 20P



BASE

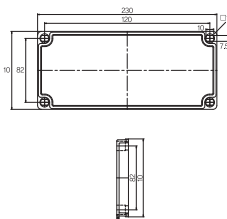

COVER

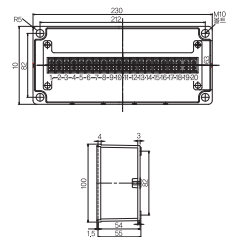

Model size / 모델사이즈 / 型号尺寸		Product model / 제품모델 / 产品型号					
Size (W×L×H/mm) 사이즈 / 尺寸	Size(W×L×H/inch) 사이즈 / 尺寸	ABS Grey ABS회색 / ABS灰色		ABS Grayish blue ABS청회색 / ABS青灰色		PC/ABS Grey PC/ABS회색 / PC/ABS灰色	
		Opaque 불투명 / 不透明	Transparent 투명 / 透明	Opaque 불투명 / 不透明	Transparent 투명 / 透明	Opaque 불투명 / 不透明	Transparent 투명 / 透明
100×230×70	3.94×9.06×2.76	BC-AGG-20P	BC-ATG-20P	BC-AGB-20P	BC-ATB-20P	BC-PGG-20P	BC-PTG-20P

▶ 20PT

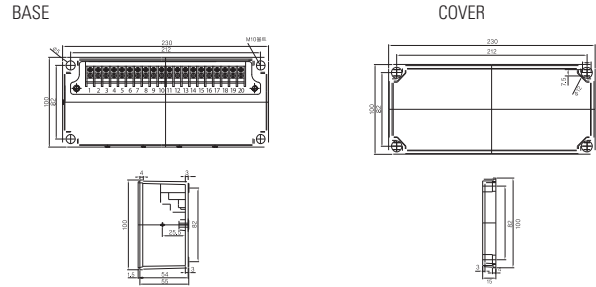

Model size / 모델사이즈 / 型号尺寸		Product model / 제품모델 / 产品型号					
Size (W×L×H/mm) 사이즈 / 尺寸	Size(WxLxH/inch) 사이즈 / 尺寸	ABS Grey ABS회색 / ABS灰色		ABS Grayish blue ABS청회색 / ABS青灰色		PC/ABS Grey PC/ABS회색 / PC/ABS灰色	
		Opaque 불투명 / 不透明	Transparent 투명 / 透明	Opaque 불투명 / 不透明	Transparent 투명 / 透明	Opaque 불투명 / 不透明	Transparent 투명 / 透明
100×230×70	3.94×9.06×2.76	BC-AGG-20PT	BC-ATG-20PT	BC-AGB-20PT	BC-ATB-20PT	BC-PGG-20PT	BC-PTG-20PT

▶ 20PA

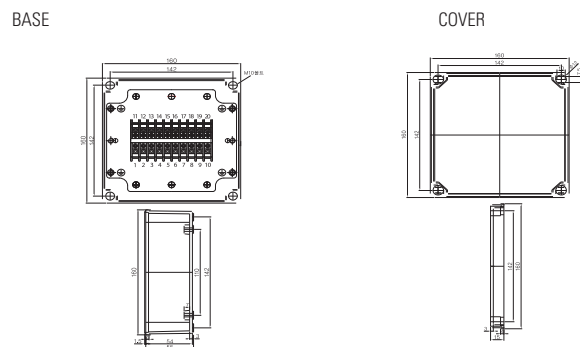

Model size / 모델사이즈 / 型号尺寸		Product model / 제품모델 / 产品型号					
Size (W×L×H/mm) 사이즈 / 尺寸	Size(WxLxH/inch) 사이즈 / 尺寸	ABS Grey ABS회색 / ABS灰色		ABS Grayish blue ABS청회색 / ABS青灰色		PC/ABS Grey PC/ABS회색 / PC/ABS灰色	
		Opaque 불투명 / 不透明	Transparent 투명 / 透明	Opaque 불투명 / 不透明	Transparent 투명 / 透明	Opaque 불투명 / 不透明	Transparent 투명 / 透明
160×160×70	6.30×6.30×2.76	BC-AGG-20PA	BC-ATG-20PA	BC-AGB-20PA	BC-ATB-20PA	BC-PGG-20PA	BC-PTG-20PA

▶ 20P2

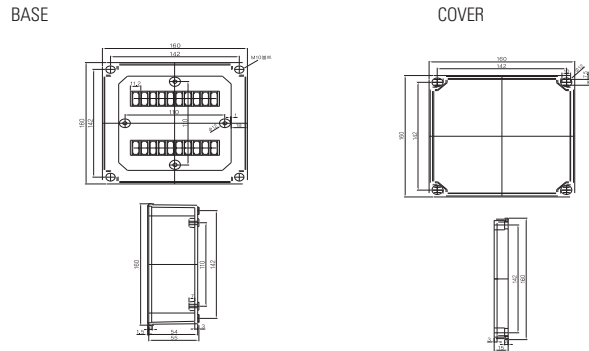

Model size / 모델사이즈 / 型号尺寸		Product model / 제품모델 / 产品型号					
Size (W×L×H/mm) 사이즈 / 尺寸	Size(WxLxH/inch) 사이즈 / 尺寸	ABS Grey ABS회색 / ABS灰色		ABS Grayish blue ABS청회색 / ABS青灰色		PC/ABS Grey PC/ABS회색 / PC/ABS灰色	
		Opaque 불투명 / 不透明	Transparent 투명 / 透明	Opaque 불투명 / 不透明	Transparent 투명 / 透明	Opaque 불투명 / 不透明	Transparent 투명 / 透明
160x160x70	6.30x6.30x2.76	BC-AGG-20P2	BC-ATG-20P2	BC-AGB-20P2	BC-ATB-20P2	BC-PGG-20P2	BC-PTG-20P2

▶ PBT-3P

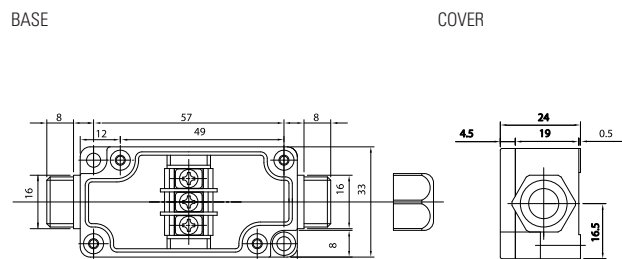

Model size / 모델사이즈 / 型号尺寸		Product model / 제품모델 / 产品型号				
Size (W×L×H/mm) 사이즈 / 尺寸	Size(WxLxH/inch) 사이즈 / 尺寸	PBT Grey PBT 회색 / PBT 灰色		PBT Black PBT 블랙 / PBT 黑色		ABS Grey ABS회색 / ABS灰色
		Opaque 불투명 / 不透明	Transparent 투명 / 透明	Opaque 불투명 / 不透明	Transparent 투명 / 透明	Opaque 불투명 / 不透明
33x65x24x9.2	1.29x2.55x0.94x0.36	BC-TGG-3PC	BC-TTG-3PC	BC-TBB-3PC	BC-TTB-3PC	BC-AGG-3PC

▶ PBT-4P

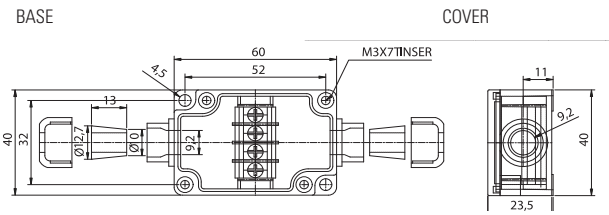

Model size / 모델사이즈 / 型号尺寸		Product model / 제품모델 / 产品型号				
Size (W×L×H/mm) 사이즈 / 尺寸	Size(WxLxH/inch) 사이즈 / 尺寸	PBT Grey PBT 회색 / PBT 灰色		PBT Black PBT 블랙 / PBT 黑色		ABS Grey ABS회색 / ABS灰色
		Opaque 불투명 / 不透明	Transparent 투명 / 透明	Opaque 불투명 / 不透明	Transparent 투명 / 透明	Opaque 불투명 / 不透明
40x60x24x9.2	1.57x2.36x0.94x0.36	BC-TGG-4PC	BC-TTG-4PC	BC-TBB-4PC	BC-TTB-4PC	BC-AGG-4PC

▶ PBT-6P

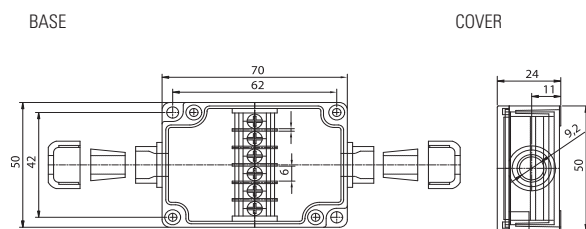

Model size / 모델사이즈 / 型号尺寸		Product model / 제품모델 / 产品型号				
Size (W×L×H/mm) 사이즈 / 尺寸	Size(WxLxH/inch) 사이즈 / 尺寸	PBT Grey PBT 회색 / PBT 灰色		PBT Black PBT 블랙 / PBT 黑色		ABS Grey ABS회색 / ABS灰色
		Opaque 불투명 / 不透明	Transparent 투명 / 透明	Opaque 불투명 / 不透明	Transparent 투명 / 透明	Opaque 불투명 / 不透明
50x70x24x9.2	1.96x2.75x0.94x0.36	BC-TGG-6PC	BC-TTG-6PC	BC-TBB-6PC	BC-TTB-6PC	BC-AGG-6PC